



**B
M
W**



2 02046



3 02047



4 02201

6 02203

6 02203

5 02202



4 02201

7 06794

7 06794

5 02202



14 06795

11 06797

15 06796



16 06798

12 06800

17 06799



10 02228

18 06813

9 02227



10 02228

19 06814

9 02227



9 02227

20 06815

10 02228





Ref	Old code	CODE	Description	OE - Number	OE - Number	FEATURES	Ref	Old code	CODE	Description	OE - Number	OE - Number	FEATURES
1	-	02195	Stabilizer link	33556764428	-	Rear	11	-	06797	Bushing	31120393540	31120398350	-
2	-	02046	Stabilizer link-L	31356765933	-	M10x1,5-290 mm (Front)	12	-	06800	Bushing	31126770849 Part of	31126770850 Part of	-
3	-	02047	Stabilizer link-R	31356765934	-	M10x1,5-290 mm (Front)	13	-	06818	Bushing	33326767190	33326763473 Part of	-
4	-	02201	Tie rod end-L	32106765089	32106767781	"M14x1.5-M14x1.5-139.5 mm (TRW-ZF)"	14	-	06795	Track control arm-L	31122405861	31124036269	-
5	-	02202	Tie rod end-R	32106765090	32106767782	"M14x1.5-M14x1.5-139.5 mm (TRW-ZF)"	15	-	06796	Track control arm-R	31122405862	31124036270	-
6	-	02203	Axial joint	32216762243 Part of	32216762244 Part of	M14x1,5-M18x1,5-246 mm (TRW)	16	-	06798	Track control arm-L	31122405859	31126763699	-
7	-	06794	Axial joint	32106765235 Part of	32106765236 Part of	ZF Steering	17	-	06799	Track control arm-R	31122405860	31126763700	-
8	-	02226	Bushing	33326763092	-	-	18	-	06813	Track rod	33326765425	-	-> 11/2009 Upper
9	-	02227	Bushing	33326765534	-	"-> 11/2009 12/2009 ->"	19	-	06814	Track rod-L	33326782237	-	Upper 12/2009 ->
10	-	02228	Bushing	33326765535	33326765425 Part of	"-> 11/2009 12/2009 ->"	20	-	06815	Track rod-R	33326782238	-	Upper 12/2009 ->
							21	-	06984	Track rod	33326763473	33326777980	Rear
							22	-	06819	Track rod	33326763471	-	-





23 06970



25 06974



24 06971



26 06975



27 06976



28 06980



13 06981



28 06980



3 03597



4 03598



Ref	Old code	CODE	Description	OE - Number	OE - Number	FEATURES	Ref	Old code	CODE	Description	OE - Number	OE - Number	FEATURES
1	-	03600	Stabilizer link-L	31306792211	-	"M10x1,5-310 mm (Front EXC. Adaptive M-Suspension) (Front Adaptive M-Suspension + xDrive"	13	-	06981	Bushing	33326792551	-	-
							14	-	07010	Bushing	31126855743	-	-
							15	-	06958	Track control arm-L	31126852991	-	-
							16	-	06959	Track control arm-R	31126852992	-	-
2	-	03601	Stabilizer link-R	31306792212	-	"M10x1,5-310 mm (Front Adaptive M-Suspension + xDrive"	17	-	06965	Track control arm-L	31126854723	-	xDrive
							18	-	06966	Track control arm-R	31126854724	-	xDrive
							19	-	06968	Track control arm-L	31126854727	-	xDrive
3	-	03597	Stabilizer link-L	33506785607	-	M10x1,25-135,5 mm (Rear)	20	-	06969	Track control arm-R	31126854728	-	xDrive
4	-	03598	Stabilizer link-R	33506785608	-	M10x1,25-135,5 mm (Rear)	21	-	07008	Track control arm-L	31126855741	-	-
5	-	06955	Tie rod end-L	32106799966	-	-	22	-	07009	Track control arm-R	31126855742	-	-
6	-	06956	Tie rod end-R	32106799967	-	-	23	-	06970	Track rod-L	33326792539	-	Rear
7	-	06962	Tie rod end-L	32106797617	-	xDrive							
8	-	06963	Tie rod end-R	32106797618	-	xDrive	24	-	06971	Track rod-R	33326792540	-	Rear
9	-	06957	Axial joint	31106799960 Part of	31106799965 Part of	-							
10	-	06964	Axial joint	32106792029 Part of	32106792030 Part of	xDrive	25	-	06974	Track rod-L	33326792543	-	Rear
11	-	06773	Bushing	31106786959	31126852991 Part of	xDrive							
12	-	06967	Bushing	31126854729	-	xDrive	26	-	06975	Track rod-R	33326792544	-	Rear
							27	-	06976	Track rod	33326792533	-	Rear
							28	-	06980	Track rod	33326792525	-	Rear



X2 (F39) (11/2017-->)
BMW 2-SERIE ACTIVE TOUR (F45) (09/2014-->)
BMW 2-SERIE GRAN TOURER (F46) (03/2015-->)

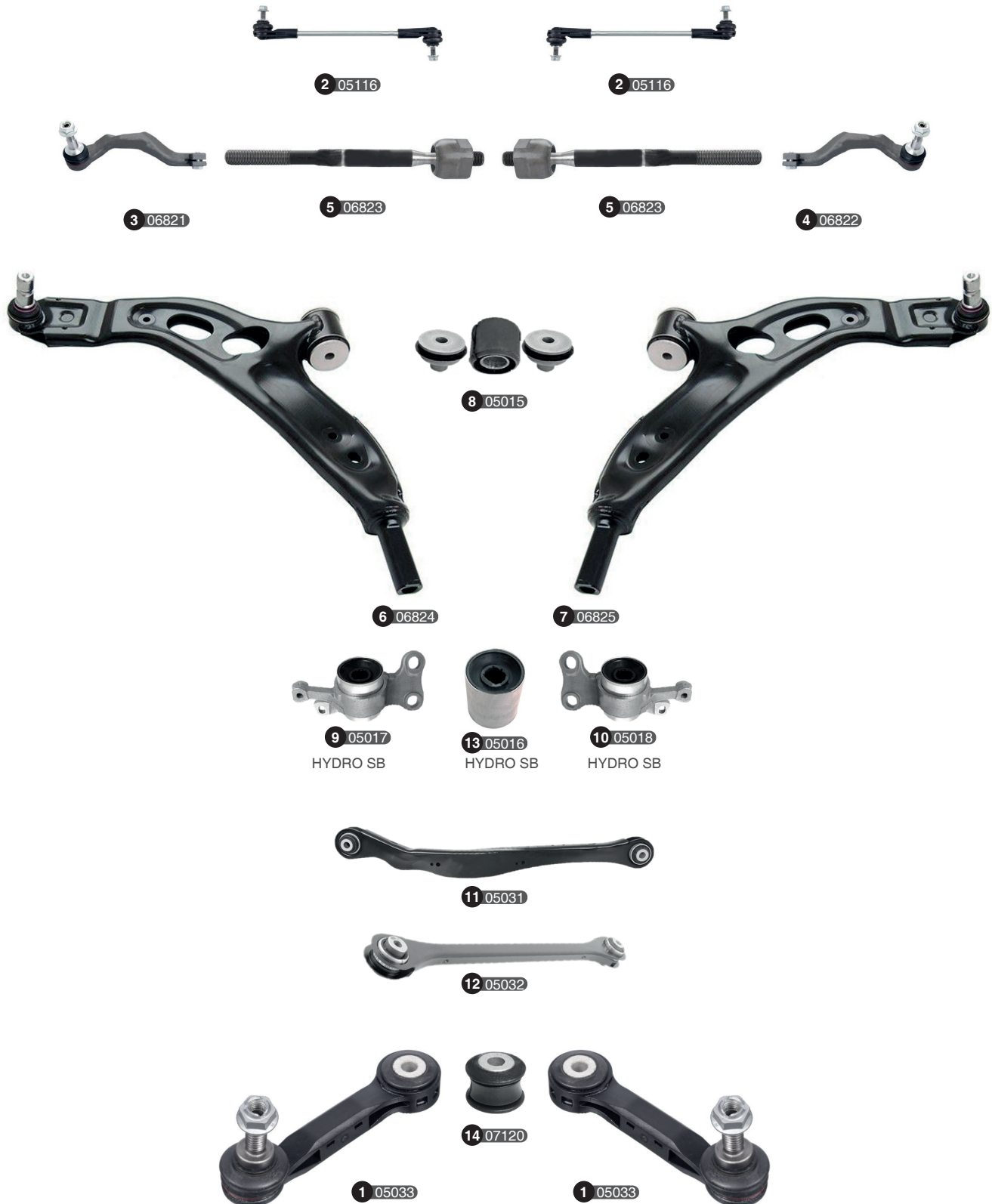



Ref	Old code	CODE	Description	OE – Number	OE – Number	FEATURES	Ref	Old code	CODE	Description	OE – Number	OE – Number	FEATURES
1	-	05033	Stabilizer link	33506862865	-	Rear	8	-	05015	Bushing (KIT)	31126850397 Part of	31126850398 Part of	KIT
2	-	05116	Stabilizer link	31306862864	-	Front	9	-	05017	Bushing-L	31126850403	31126874341	-
3	-	06821	Tie rod end-L	32106869424	-	-	10	-	05018	Bushing-R	31126850404	31126874342	-
4	-	06822	Tie rod end-R	32106869425	-	-	11	-	05031	Track rod	33326851563	33326870773	Upper
5	-	06823	Axial joint	32106867404 Part of	32106867405 Part of	-	12	-	05032	Track rod	33326851569	-	Lower
6	-	06824	Control arm complete-L	31122785113	31126851203	-	13	-	05016	Bushing	31126874343	-	-
7	-	06825	Control arm complete-R	31122785114	31126851204	-	14	-	07120	Bushing	33506862865 PART OF	-	-





BMW 2-SERIE COUPE (F22) (10/2013-->)
BMW 2-SERIE CABRIO (F23) (11/2014-->)



1 03600



2 03601



5 06955



9 06957



9 06957



6 06956



7 06962



10 06964



10 06964



8 06963



21 07008



14 07010



22 07009



15 06958



12 06967



16 06959



17 06965



12 06967



18 06966



19 06968



11 06773



20 06969



23 06970



24 06971



25 06974



26 06975





Ref	Old code	CODE	Description	OE - Number	OE - Number	FEATURES	Ref	Old code	CODE	Description	OE - Number	OE - Number	FEATURES
1	-	03600	Stabilizer link-L	31306792211	-	"M10x1,5-310 mm (Front EXC. Adaptive M-Suspension) (Front Adaptive M-Suspension + xDrive"	12	-	06967	Bushing	31126854729	-	xDrive
							13	-	06981	Bushing	33326792551	-	-
							14	-	07010	Bushing	31126855743	-	-
							15	-	06958	Track control arm-L	31126852991	-	-
							16	-	06959	Track control arm-R	31126852992	-	-
2	-	03601	Stabilizer link-R	31306792212	-	"M10x1,5-310 mm (Front Adaptive M-Suspension + xDrive"	17	-	06965	Track control arm-L	31126854723	-	xDrive
							18	-	06966	Track control arm-R	31126854724	-	xDrive
							19	-	06968	Track control arm-L	31126854727	-	xDrive
3	-	03597	Stabilizer link-L	33506785607	-	M10x1,25-135,5 mm (Rear)	20	-	06969	Track control arm-R	31126854728	-	xDrive
4	-	03598	Stabilizer link-R	33506785608	-	M10x1,25-135,5 mm (Rear)	21	-	07008	Track control arm-L	31126855741	-	-
5	-	06955	Tie rod end-L	32106799966	-	-	22	-	07009	Track control arm-R	31126855742	-	-
6	-	06956	Tie rod end-R	32106799967	-	-	23	-	06970	Track rod-L	33326792539	-	Rear
7	-	06962	Tie rod end-L	32106797617	-	xDrive	24	-	06971	Track rod-R	33326792540	-	Rear
8	-	06963	Tie rod end-R	32106797618	-	xDrive	25	-	06974	Track rod-L	33326792543	-	Rear
9	-	06957	Axial joint	31106799960 Part of	31106799965 Part of	-	26	-	06975	Track rod-R	33326792544	-	Rear
10	-	06964	Axial joint	32106792029 Part of	32106792030 Part of	xDrive	27	-	06976	Track rod	33326792533	-	Rear
11	-	06773	Bushing	31106786959	31126852991 Part of	xDrive	28	-	06980	Track rod	33326792525	-	Rear

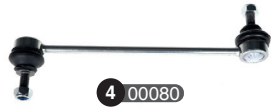



2 01551



2 01551



Ref	Old code	CODE	Description	OE - Number	OE - Number	FEATURES	Ref	Old code	CODE	Description	OE - Number	OE - Number	FEATURES
1	BMW01	00078	Stabilizer link	31351091764	31351127689	M10x1,5-66 mm (Front EXC. 4X4 M3)	7	BMW11-R	00089	Axial joint-R	32111126620	32111130451	"M14x1,5-M18x1,5-229,5 mm (WITH STEERING DAMPER)
2	-	01551	Stabilizer link	33551124375	33551126932	100 mm (Rear)							
3	-	01609	Stabilizer link	31351701066	-	325iX (Front)							
4	BMW03	00080	Stabilizer link	31351124380	31351127194	M10x1,5-239 mm (Front M3 2.3)	8	-	01509	Control arm complete-L	31121127725	-	320,7 mm ALL (M3 -> 09/1988 - EXC. 4x4)
5	BMW10	00087	Tie rod end	32111126757	-	"M10x1.25-M14X1.5-200 mm (WITHOUT STEERING DAMPER) (WITH STEERING DAMPER)"	9	-	01508	Control arm complete-R	31121127726	-	320,7 mm ALL (M3 -> 09/1988 - EXC. 4x4)
							10	BMW13	00090	Ball joint	31121126254	-	M12x1,5 ALL (M3 -> 09/1988 - EXC. 4x4)
6	BMW11-L	00088	Axial joint-L	32111127124	32111130449	"M14x1,5-M18x1,5-230 mm (WITHOUT STEERING DAMPER) (WITH STEERING DAMPER)"	11	BMW20	00098	Ball joint	31121126253	-	M14x1,5 ALL (M3 -> 09/1988 - EXC. 4x4)
							12	-	01550	Ball joint	31121701077	-	M14x1,5 (325iX)
							13	-	02254	Bushing	31121139789	-	All (M3 -> 09/1988 - EXC. 4x4)
							14	-	02255	Bushing	31121139790	-	All (M3 -> 09/1988 - EXC. 4x4)

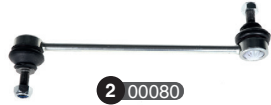



Ref	Old code	CODE	Description	OE - Number	OE - Number	FEATURES	Ref	Old code	CODE	Description	OE - Number	OE - Number	FEATURES
1	BMW01	00078	Stabilizer link	31351091764	31351127689	M10x1,5-66 mm	9	-	01554	Axial joint	32111139318	-	M14x1,5- M18x1,5-205 mm
2	BMW03	00080	Stabilizer link	31351124380	31351127194	M10x1,5-239 mm	10	BMW60-L	00146	Control arm complete-L	31121094275	31121136529R	320,6 mm
3	-	01551	Stabilizer link	33551124375	33551126932	100 mm	11	BMW60-R	00147	Control arm complete-R	31121094276	31121094276R	320,6 mm
4	-	02204	Stabilizer link	33551135307	-	60 mm	12	BMW19	00097	Ball joint	31121096685	31121140398	M12x1,5
5	-	02662	Stabilizer link	31352227203	LR002876	M10x1,5-229 mm	13	-	06802	Ball joint	31121139131	-	EXC. M3
6	BMW17-L	00094	Tie rod end-L	32111139313	-	M10x1,5-Female- M14x1,5-214 mm	14	-	06803	Ball joint	31121096685 Part of	31121140398 Part of	EXC. M3 REINFORCED
7	BMW17-R	00095	Tie rod end-R	32111139314	-	M10x1,25- Female- M14x1,5-214 mm	15	-	06760	Bushing	33321136311	33326471828	-
8	BMW18	00096	Axial joint	32111139315 Part of	32111139316 Part of	M14x1,5- M18x1,5-206 mm	16	-	06761	Bushing	33321092248	33321138383	-
							17	-	02253	Bushing-L	31121136531	-	EXC. M3
							18	-	02252	Bushing-R	31121136532	-	EXC. M3
							19	-	06759	Track control arm	33303411651	33321092237	-





Ref	Old code	CODE	Description	OE - Number	OE - Number	FEATURES	Ref	Old code	CODE	Description	OE - Number	OE - Number	FEATURES
1	BMW02	00079	Stabilizer link	31351095694	31356780847	M10x1,5-272 mm (Front EXC. XI-XD)	12	BMW46-R	00125	Control arm complete-R	31122341828	31122343352R	355 mm (EXC. XI-XD Reinforced)
2	-	01553	Stabilizer link	33551094619	-	95 mm (Rear)	13	-	06300	Control arm complete-L	31122282121 Part of	31122341297 Part of	EXC. XI-XD Reinforced with SB and Reinforced
3	-	01836	Stabilizer link-L	31356751079	-	M10x1,5-308 mm (Front XI-XD)	14	-	06301	Control arm complete-R	31122282122 Part of	31122341828 Part of	EXC. XI-XD Reinforced with SB and Reinforced
4	-	01837	Stabilizer link-R	31356751080	-	M10x1,5-308 mm (Front XI-XD)	15	-	06842	Control arm complete-L	31121096221	31126758533	XI-XD
5	BMW57-L	00144	Tie rod end-L	32111095957	32106774220	EXC. XI-XD	16	-	06843	Control arm complete-R	31121096222	31126758534	XI-XD
6	BMW57-R	00145	Tie rod end-R	32111095958	32106774221	EXC. XI-XD	17	-	06846	Ball joint	31121096685R	31121140398R	XI-XD
7	-	06839	Tie rod end-L	32106774320	32216751041	XI-XD	18	-	06844	Ball joint-L	31126756695	-	XI-XD
8	-	06840	Tie rod end-R	32106774321	32216751042	XI-XD	19	-	06845	Ball joint-R	31126756696	-	XI-XD
9	BMW37	00114	Axial joint	32111096897	32106774222 Part of	M14x1,5-M18x1,5-205 mm (EXC. XI-XD)	20	-	06760	Bushing	33321136311	33326471828	-
10	-	06841	Axial joint	32106774318 Part of	32106774319 Part of	XI-XD	21	-	06761	Bushing	33321092248	33321138383	-
11	BMW46-L	00124	Control arm complete-L	31122341297	31122343353R	355 mm (EXC. XI-XD Reinforced)	22	-	02250	Bushing-L	31126756063	-	-
							23	-	02251	Bushing-R	31126756064	-	-
							24	-	06759	Track control arm	33303411651	33321092237	-





Ref	Old code	CODE	Description	OE - Number	OE - Number	FEATURES	Ref	Old code	CODE	Description	OE - Number	OE - Number	FEATURES
1	-	02195	Stabilizer link	33556764428	-	Rear	14	-	02226	Bushing	33326763092	-	-
2	-	02046	Stabilizer link-L	31356765933	-	M10x1,5-290 mm (Front EXC. XI - XD)	15	-	02227	Bushing	33326765534	-	-
							16	-	02228	Bushing	33326765535	33326765425 Part of	-
3	-	02047	Stabilizer link-R	31356765934	-	M10x1,5-290 mm (Front EXC. XI - XD)	17	-	06797	Bushing	31120393540	31120398350	EXC. XI - XD
							18	-	06800	Bushing	31126770849 Part of	31126770850 Part of	EXC. XI - XD
4	-	06804	Stabilizer link-L	31356768771	-	Front XI - XD	19	-	06810	Bushing	31126768991	31126768989 Part of	XI-XD
							20	-	06812	Bushing	31120410791	31126768818	XI-XD
5	-	06805	Stabilizer link-R	31356768772	-	Front XI - XD	21	-	06818	Bushing	33326767190	33326763473 Part of	-
							22	-	06809	Track control arm	31126768989	-	XI-XD
6	-	02201	Tie rod end-L	32106765089	32106767781	"M14x1.5-M14x1.5-139.5 mm (EXC. XI - XD TRW Steering) (EXC. XI - XD ZF Steering)"	23	-	03807	Track control arm-L	00029001751501	31126768983	XI-XD
							24	-	03808	Track control arm-R	00029001851501	31126768984	XI-XD
7	-	02202	Tie rod end-R	32106765090	32106767782	"M14x1.5-M14x1.5-139.5 mm (EXC. XI - XD TRW Steering) (EXC. XI - XD ZF Steering)"	25	-	06795	Track control arm-L	31122405861	31124036269	EXC. XI - XD
							26	-	06796	Track control arm-R	31122405862	31124036270	EXC. XI - XD
8	-	06806	Tie rod end-L	32106769073	32106793623	XI-XD	27	-	06798	Track control arm-L	31122405859	31126763699	EXC. XI - XD
9	-	06807	Tie rod end-R	32106769074	32106793624	XI-XD	28	-	06799	Track control arm-R	31122405860	31126763700	EXC. XI - XD
10	-	02203	Axial joint	32216762243 Part of	32216762244 Part of	"M14x1,5-M18x1,5-246 mm (EXC. XI - XD TRW Steering)"	29	-	06813	Track rod	33326765425	-	-> 11/2009 Upper
							30	-	06814	Track rod-L	33326782237	-	Upper 12/2009 ->
11	-	06794	Axial joint	32106765235 Part of	32106765236 Part of	EXC. XI - XD ZF Steering	31	-	06815	Track rod-R	33326782238	-	Upper 12/2009 ->
12	-	06808	Axial joint	32106768879 Part of	32106768880 Part of	XI-XD	32	-	06819	Track rod	33326763471	-	-
13	-	06811	Ball joint	31126768988	-	XI-XD	33	-	06984	Track rod	33326763473	33326777980	Rear







BMW 3-SERIE (F30, F31) (10/2011-->)
BMW 3-SERIE GT (F34) (10/2015-->)



Ref	Old code	CODE	Description	OE - Number	OE - Number	FEATURES	Ref	Old code	CODE	Description	OE - Number	OE - Number	FEATURES
1	-	03600	Stabilizer link-L	31306792211	-	"M10x1,5-310 mm (Front EXC. Adaptive M-Suspension) (Front Adaptive M-Suspension + xDrive)"	14	-	07010	Bushing	31126855743	-	-
							15	-	06958	Track control arm-L	31126852991	-	-
							16	-	06959	Track control arm-R	31126852992	-	-
2	-	03601	Stabilizer link-R	31306792212	-	"M10x1,5-310 mm (Front Adaptive M-Suspension + xDrive)"	17	-	06965	Track control arm-L	31126854723	-	xDrive F30, F31
							18	-	06966	Track control arm-R	31126854724	-	xDrive F30, F31
							19	-	06968	Track control arm-L	31126854727	-	xDrive
3	-	03597	Stabilizer link-L	33506785607	-	M10x1,25-135,5 mm (Rear)	20	-	06969	Track control arm-R	31126854728	-	xDrive
4	-	03598	Stabilizer link-R	33506785608	-	M10x1,25-135,5 mm (Rear)	21	-	07008	Track control arm-L	31126855741	-	-
5	-	06955	Tie rod end-L	32106799966	-	-	22	-	07009	Track control arm-R	31126855742	-	-
6	-	06956	Tie rod end-R	32106799967	-	-	23	-	07011	Track control arm-L	31126798253	-	xDrive F34
7	-	06962	Tie rod end-L	32106797617	-	xDrive	24	-	07012	Track control arm-R	31126798254	-	xDrive F34
8	-	06963	Tie rod end-R	32106797618	-	xDrive	25	-	06970	Track rod-L	33326792539	-	Rear
9	-	06957	Axial joint	31106799960 Part of	31106799965 Part of	-	26	-	06971	Track rod-R	33326792540	-	Rear
10	-	06964	Axial joint	32106792029 Part of	32106792030 Part of	xDrive	27	-	06974	Track rod-L	33326792543	-	Rear
11	-	06773	Bushing	31106786959	31126852991 Part of	All	28	-	06975	Track rod-R	33326792544	-	Rear
12	-	06967	Bushing	31126854729	-	"xDrive F30, F31xDrive F34"	29	-	06976	Track rod	33326792533	-	Rear
13	-	06981	Bushing	33326792551	-	-	30	-	06980	Track rod	33326792525	-	Rear



BMW 4-SERIE COUPE (F32) (07/2013-->)
BMW 4-SERIE CABRIO (F33) (10/2013-->)
BMW 4-SERIE GRAND COUPE (F36) (03/2014-->)





BMW 4-SERIE COUPE (F32) (07/2013-->)
BMW 4-SERIE CABRIO (F33) (10/2013-->)
BMW 4-SERIE GRAND COUPE (F36) (03/2014-->)



Ref	Old code	CODE	Description	OE - Number	OE - Number	FEATURES	Ref	Old code	CODE	Description	OE - Number	OE - Number	FEATURES
1	-	03600	Stabilizer link-L	31306792211	-	"M10x1,5-310 mm (Front EXC. Adaptive M-Suspension) (Front Adaptive M-Suspension + xDrive"	11	-	06773	Bushing	31106786959	31126852991 Part of	-
							12	-	06967	Bushing	31126854729	-	xDrive
							13	-	06981	Bushing	33326792551	-	-
							14	-	07010	Bushing	31126855743	-	-
							15	-	06958	Track control arm-L	31126852991	-	-
2	-	03601	Stabilizer link-R	31306792212	-	"M10x1,5-310 mm (Front Adaptive M-Suspension + xDrive"	16	-	06959	Track control arm-R	31126852992	-	-
							17	-	06965	Track control arm-L	31126854723	-	xDrive
							18	-	06966	Track control arm-R	31126854724	-	xDrive
3	-	03597	Stabilizer link-L	33506785607	-	M10x1,25-135,5 mm (Rear)	19	-	06968	Track control arm-L	31126854727	-	xDrive
4	-	03598	Stabilizer link-R	33506785608	-	M10x1,25-135,5 mm (Rear)	20	-	06969	Track control arm-R	31126854728	-	xDrive
5	-	06955	Tie rod end-L	32106799966	-	-	21	-	07008	Track control arm-L	31126855741	-	-
6	-	06956	Tie rod end-R	32106799967	-	-	22	-	07009	Track control arm-R	31126855742	-	-
7	-	06962	Tie rod end-L	32106797617	-	xDrive	23	-	06970	Track rod-L	33326792539	-	Rear
8	-	06963	Tie rod end-R	32106797618	-	xDrive	24	-	06971	Track rod-R	33326792540	-	Rear
9	-	06957	Axial joint	31106799960 Part of	31106799965 Part of	-	25	-	06974	Track rod-L	33326792543	-	Rear
							26	-	06975	Track rod-R	33326792544	-	Rear
10	-	06964	Axial joint	32106792029 Part of	32106792030 Part of	xDrive	27	-	06976	Track rod	33326792533	-	Rear
							28	-	06980	Track rod	33326792525	-	Rear



Ref	Old code	CODE	Description	OE - Number	OE - Number	FEATURES	Ref	Old code	CODE	Description	OE - Number	OE - Number	FEATURES
1	BMW03	00080	Stabilizer link	31351124380	31351127194	M10x1,5-239 mm (Front)	6	-	06789	Bushing	31121124622	-	-
2	-	01534	Stabilizer link	33321123463	33321125665	50 mm (Rear)	7	-	01522	Track control arm-L	31121124401	31121131587	M14x1,5-325 mm
3	-	01551	Stabilizer link	33551126932	33551124375	100 mm (Rear)	8	-	01521	Track control arm-R	31121124402	31121131582	M14x1,5-325 mm
4	BMW16	00093	Tie rod end	32211127918	32211130001	Inner	9	-	01639	Track Control arm w/o bushing-L	31121125549	31121124954	-
5	BMW42 (MCD18)	00119	Tie rod end	0003381910	0003380710	M10x1,25-Male-M14x1,5-88 mm	10	-	01640	Track control arm w/o bushing-R	31121125550	31121124955	-



Ref	Old code	CODE	Description	OE - Number	OE - Number	FEATURES	Ref	Old code	CODE	Description	OE - Number	OE - Number	FEATURES
1	BMW03	00080	Stabilizer link	31351124380	31351127194	M10x1,5-239 mm (Front)	8	-	06789	Bushing	31121124622	-	Steel
2	-	01534	Stabilizer link	33321123463	33321125665	50 mm (Rear)	9	BMW47-L	00126	Track control arm-L	31121133237	31121139987	M14x1,5-323 mm (Aluminium)
3	-	02204	Stabilizer link	33551135307	-	60 mm (Rear)	10	BMW47-R	00127	Track control arm-R	31121133238	31121139988	M14x1,5-323 mm (Aluminium)
4	BMW16	00093	Tie rod end	32211127918	32211130001	Inner	11	-	01522	Track control arm-L	31121124401	31121131587	M14x1,5-325 mm (Steel)
5	BMW42 (MCD18)	00119	Tie rod end	32211114842	32211127917	M10x1,25-Male-M14x1,5-88 mm	12	-	01521	Track control arm-R	31121124402	31121131582	M14x1,5-325 mm (Steel)
6	-	02221	Bushing	31121136605	31121136606	-	13	-	01564	Track control arm-L	31121132159	31121133711	M14x1,5
7	-	06906	Bushing	31106770689 Part of	31106770690 Part of	Aluminium	14	-	01565	Track control arm-R	31121132160	31121133712	M14x1,5



BMW 5-SERIE (E39) 520d-520i-520i M-523i
525d-525i-525td-525tds-528i-530d-530 (11/1995-05/2004)





20 02220



20 02220



1 00085



1 00085



Ref	Old code	CODE	Description	OE - Number	OE - Number	FEATURES	Ref	Old code	CODE	Description	OE - Number	OE - Number	FEATURES
1	BMW07	00085	Stabilizer link	33551092292	33551095532	M10x1,5-66 mm (Rear)	11	-	06791	Bushing	33326470859 Part of	33326470860 Part of	-
2	BMW06-L	00083	Stabilizer link-L	31351091885	31351095661	M10x1,5-239 mm (Front)	12	BMW52	00136	Track control arm	33321090745	33321097264	M10x1.5-211,5 mm (-> 12/2001)
3	BMW06-R	00084	Stabilizer link-R	31351091856	31351095662	M10x1,5-239 mm (Front)	13	BMW56	00143	Track control arm	33320300946	33320398361	M10x1.5-212 mm (12/2001 ->)
4	BMW14-L	00091	Tie rod end-L	32111091769	-	M12x1.5-M16X1-229 mm	14	BMW49-L	00130	Track control arm-L	31121092023	31121141717	M14x1.5-431 mm
5	BMW14-R	00092	Tie rod end-R	32111091770	-	M12x1.5-M16X1-229 mm	15	BMW49-R	00131	Track control arm-R	31121092024	31121141718	M14x1.5-431 mm
6	BMW36	00113	Axial joint	32111094673 Part of	32111094674 Part of	M16x1-M18x1,5-174 mm	16	BMW51-L	00134	Track control arm-L	31121093449	31121094233	M14x1.5-310 mm
7	-	06905	Bushing	31129068753	-	-	17	BMW51-R	00135	Track control arm-R	31121093450	31121094234	M14x1.5-310 mm
8	-	06906	Bushing	31106770689 Part of	31106770690 Part of	-	18	BMW50-L	00132	Track control arm-L	33321090815	33321094209	M14x1.5-306,5 mm
9	-	06521	Bushing	33326768791 Part of	-	-> 12/2001	19	BMW50-R	00133	Track control arm-R	33321090816	33321094210	M14x1.5-306,5 mm
10	-	06904	Bushing	33320300946 Part of	33320398361 Part of	12/2001 ->	20	-	02220	Track rod	33321090030	33321091620	165 mm (Rear)

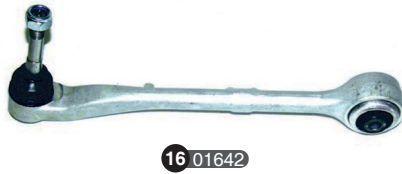



18 02220



18 02220



1 00085



1 00085



Ref	Old code	CODE	Description	OE - Number	OE - Number	FEATURES	Ref	Old code	CODE	Description	OE - Number	OE - Number	FEATURES
1	BMW07	00085	Stabilizer link	33551092292	33551095532	M10x1,5-66 mm (Rear)	10	BMW52	00136	Track control arm	33321090745	33321097264	M10x1.5-211,5 mm ->12/2001
2	-	01484	Stabilizer link	31351091664	31351092304	M10x1,5-285 mm (Front)	11	BMW56	00143	Track control arm	33320300946	33320398361	M10x1.5-212 mm 12/2001->
3	BMW43-L	00120	Tie rod end-L	32211091723	-	-	12	BMW50-L	00132	Track control arm-L	33321090815	33321094209	M14x1.5-306,5 mm
4	BMW43-R	00121	Tie rod end-R	32211091724	-	-	13	BMW50-R	00133	Track control arm-R	33321090816	33321094210	M14x1.5-306,5 mm
5	-	02225	Bushing	31120006482	31121141752	-	14	-	01641	Track control arm-L	31121092609	31121092819	Aluminium Lower
6	-	06521	Bushing	33326768791 Part of	-	-> 12/2001	15	-	01643	Track control arm-R	31121092610	31121092820	Aluminium Lower
7	-	06791	Bushing	33326470859 Part of	33326470860 Part of	-	16	-	01642	Track control arm-L	31121141961	-	-
8	-	06903	Bushing	31121141961 Part of	31121141962 Part of	-	17	-	03541	Track control arm-R	31121141962	-	-
9	-	06904	Bushing	33320300946 Part of	33320398361 Part of	-	18	-	02220	Track rod	33321090030	33326770749	165 mm (Rear)



BMW 5-SERIE (E60) (07/2003-03/2010)
BMW 5-SERIE TOURING (E61) (06/2004-08/2010)





BMW 5-SERIE (E60) (07/2003-03/2010)
BMW 5-SERIE TOURING (E61) (06/2004-08/2010)



Ref	Old code	CODE	Description	OE - Number	OE - Number	FEATURES	Ref	Old code	CODE	Description	OE - Number	OE - Number	FEATURES
1	BMW38	00115	Stabilizer link	33506781540	33556761000	M10x1,5-131 mm (Rear EXC. Active Stab.)	16	BMW56	00143	Track control arm	33320300946	33320398361	M10x1.5-212 mm
2	-	02664	Stabilizer link	33506768493	33506781537	M12x1,5-158 mm (Rear Active Stab.)	17	BMW48-L	00128	Track control arm-L	33306772241	33326767759	M14x1.5-305 mm (02/2005 ->)
3	BMW44-L	00122	Stabilizer link-L	31354014531	31306781547	M10x1,5-300 mm (Front EXC. XI - XD)	18	BMW48-R	00129	Track control arm-R	33306772242	33326767760	M14x1.5-305 mm (02/2005 ->)
4	BMW44-R	00123	Stabilizer link-R	31354014532	31306781548	M10x1,5-300 mm (Front EXC. XI - XD)	19	BMW53-L	00137	Track control arm-L	33306773941	33326759157	M14x1.5-306 mm (-> 03/2005)
5	-	01948	Stabilizer link-L	31306781549	31356768083	M10x1,5-421 mm (Front XI - XD)	20	BMW53-R	00138	Track control arm-R	33306773942	33326759158	M14x1.5-306 mm (-> 03/2005)
6	-	01949	Stabilizer link-R	31306781550	31356768084	M10x1,5-421 mm (Front XI - XD)	21	-	03278	Track control arm-L	31124028607	31122347963	Aluminium EXC. XI - XD
7	-	01559	Tie rod end	32106774361	32106776946	M14x1,25-Female-M16x1,5-160 mm (EXC. XI - XD)	22	-	03279	Track control arm-R	31124028608	31122347965	Aluminium EXC. XI - XD
8	-	02003	Tie rod end	32216767860	-	M14x1,5-Female-M16x1,5-160mm (XI - XD)	23	-	05182	Track control arm-L	33326775083	-	" 09/2006 -> 530i-550i + Bad road pack "
9	-	01776	Axial joint	32106774347 Part of	32106777479 Part of	M16x1,5-M18x1,5-262 mm (EXC. XI - XD)(XI - XD)	24	-	05183	Track control arm-R	33326775084	-	" 09/2006 -> 530i-550i + Bad road pack "
10	-	06948	Ball joint	31104038994	31126769307	XI-XD	25	-	06943	Track control arm-L	31102348047	31104026719	EXC. XI - XD
11	-	06942	Bushing	33326762732 Part of	33326770775 Part of	-	26	-	06944	Track control arm-R	31102348046	31104026720	EXC. XI - XD
12	-	06945	Bushing	31120305612 Part of	31126765922 Part of	EXC. XI - XD	27	-	06946	Track control arm-L	31106770685	-	XI-XD
13	-	06906	Bushing	1106770690 Part of	31106770689 Part of	EXC. XI - XD	28	-	06947	Track control arm-R	31106770686	-	XI-XD
14	-	06949	Bushing	31120406872	31126768302	XI-XD	29	-	06950	Track control arm-L	31106770689	31122347981	XI-XD
15	-	06904	Bushing	33320300946 Part of	33320398361 Part of	-	30	-	06951	Track control arm-R	31106770690	31122347982	XI-XD
							31	-	02220	Track rod	33321090030	33321091620	165 mm (Rear)





BMW 5-SERIE (F10) (03/2010-10/2016)
BMW 5-SERIE TOURING (F11) (09/2010-->)
BMW 5-SERIE GRAND TURISMO (F07GT) (10/2009-->)

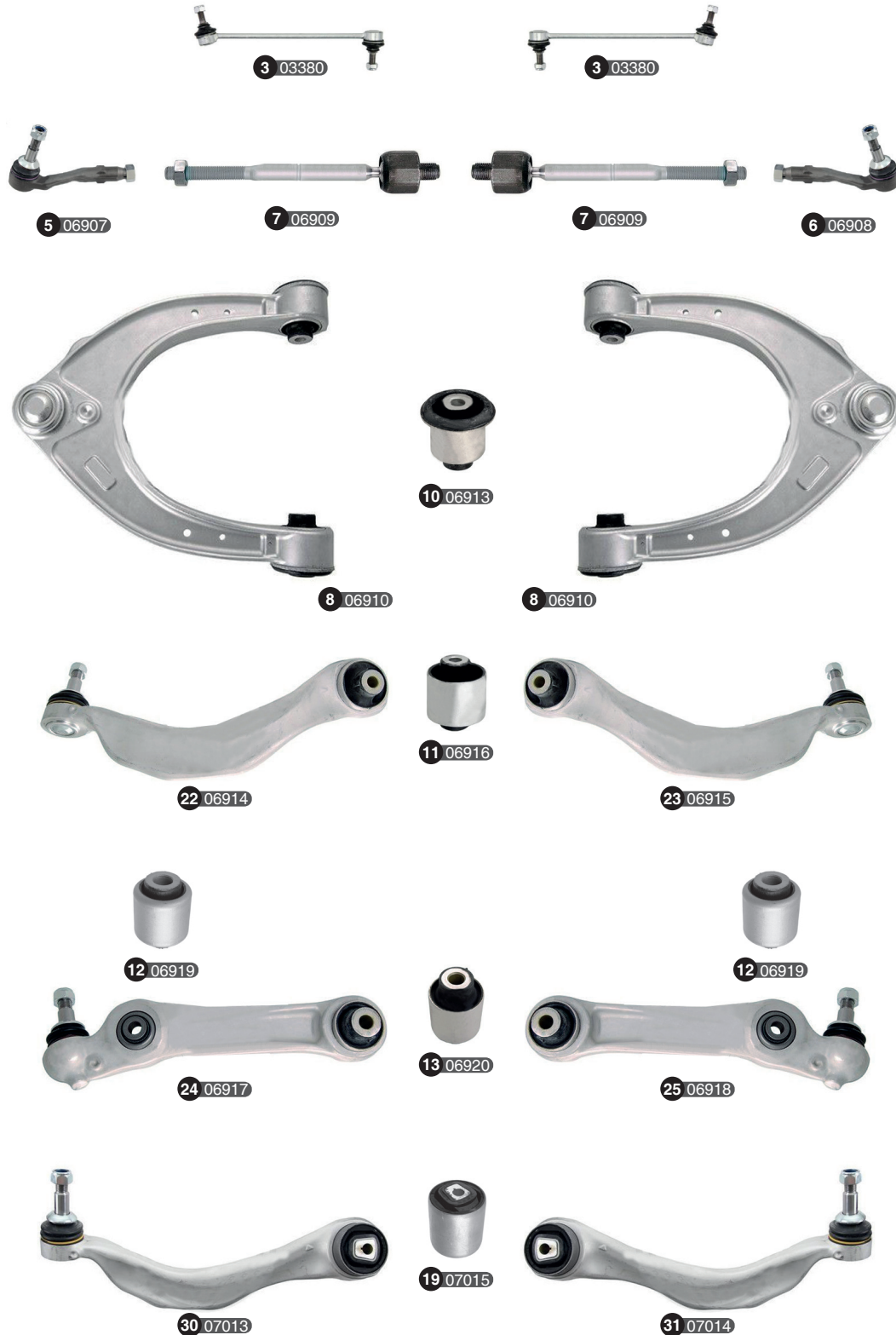



BMW 5-SERIE (F10) (03/2010-10/2016)
BMW 5-SERIE TOURING (F11) (09/2010-->)
BMW 5-SERIE GRAND TURISMO (F07GT) (10/2009-->)





BMW 5-SERIE (F10) (03/2010-10/2016)
BMW 5-SERIE TOURING (F11) (09/2010-->)
BMW 5-SERIE GRAND TURISMO (F07GT) (10/2009-->)





BMW 5-SERIE (F10) (03/2010-10/2016)
BMW 5-SERIE TOURING (F11) (09/2010-->)
BMW 5-SERIE GRAND TURISMO (F07GT) (10/2009-->)

Ref	Old code	CODE	Description	OE – Number	OE – Number	FEATURES	Ref	Old code	CODE	Description	OE – Number	OE – Number	FEATURES
1	-	03381	Stabilizer link	37106775189	-	Rear Dynamic Drive	20	-	07019	Bushing	31126775963 Part of	31126775980 Part of	Lower F07GT
2	-	03617	Stabilizer link	33556777635	-	Rear EXC. Dynamic Drive	21	-	06931	Track control arm	33326775902	-	Upper Rear F10
3	-	03380	Stabilizer link	31356777319	-	Front	22	-	06914	Track control arm-L	31126779871 Part of	-	Lower EXC. F07GT
4	-	07028	Stabilizer link	33556786429	-	Rear Upper F11 + F07GT	23	-	06915	Track control arm-R	31126775972	-	Lower EXC. F07GT
5	-	06907	Tie rod end-L	32106784790	-	-	24	-	06917	Track control arm-L	31126794203	-	Lower EXC. F07GT
6	-	06908	Tie rod end-R	32106784796	-	-	25	-	06918	Track control arm-R	31126794204	-	Lower EXC. F07GT
7	-	06909	Axial joint	32106784716 Part of	32106784719 Part of	-	26	-	06921	Track control arm-L	31124083309	-	"Lower XDrive Lower XDrive EXC.F07GT"
8	-	06910	Control arm complete	31126775967	-	Upper	27	-	06922	Track control arm-R	31124083310	31126777734	"Lower XDrive Lower XDrive EXC.F07GT"
9	-	06926	Ball joint	31126777753	-	"Lower XDrive Lower XDrive EXC.F07GT Lower XDrive F07GT"	28	-	06924	Track control arm-L	31126777743	31126850605	"Lower XDrive Lower XDrive EXC.F07GT"
10	-	06913	Bushing	31126775967 Part of	-	Upper	29	-	06925	Track control arm-R	31126777744	31126850606	"Lower XDrive Lower XDrive EXC.F07GT"
11	-	06916	Bushing	31126775971 Part of	31126775972 Part of	Lower EXC. F07GT	30	-	07013	Track control arm-L	31124083311	31126775659	Lower F07GT
12	-	06919	Bushing	31106861169 Part of	31106861170 Part of	"LOWER EXC. F07GT LOWER F07GT LOWER XDRIVE EXC. F07GT LOWER XDRIVE F07GT"	31	-	07014	Track control arm-R	31124083312	31126775960	Lower F07GT
13	-	06920	Bushing	31126791455	31126794203 Part of	Lower EXC. F07GT	32	-	07016	Track control arm-L	31126775963	31126798107	Lower F07GT
14	-	06923	Bushing	31126777653	-	"Lower XDrive Lower XDrive EXC.F07GT Lower XDrive F07GT"	33	-	07017	Track control arm-R	31126775964	31126798108	Lower F07GT
15	-	06744	Bushing	31126777652	31126777739 Part of	"Lower XDrive Lower XDrive EXC.F07GT Lower XDrive F07GT"	34	-	07020	Track control arm-L	31124081431	31126777729	Lower XDrive F07GT
16	-	06929	Bushing	33324069283 Part of	-	"Upper F10 Upper F11 + F07GT"	35	-	07021	Track control arm-R	31124081432	31126777730	Lower XDrive F07GT
17	-	06930	Bushing	33324069283 Part of	-	"Upper F10 Upper F11 + F07GT"	36	-	07022	Track control arm-L	31126777739	-	Lower XDrive F07GT
18	-	06932	Bushing	33326775680 Part of	-	"Upper F10 Upper F11 + F07GT"	37	-	07023	Track control arm-R	31126777740	-	Lower XDrive F07GT
19	-	07015	Bushing	31126775145	-	Lower F07GT	38	-	07025	Track control arm-L	33326779847	-	Upper F11 + F07GT
							39	-	07026	Track control arm-R	33326779848	-	Upper F11 + F07GT
							40	-	06927	Track rod-L	33324069283	33326782135	Rear Upper F10
							41	-	06928	Track rod-R	33324069284	33326782136	Rear Upper F10
							42	-	06934	Track rod	33326775683	-	Rear
							43	-	07024	Track rod	33326779851	-	Upper Rear F11 + F07GT





23 07749



8 06993



24 07750



10 06919



27 07758



25 07751



9 06996



26 07752



10 06919



27 07758



15 06997



16 06998



17 07000



18 07001



19 07002



20 07003



21 07005



2 07007



2 07007



Ref	Old code	CODE	Description	OE – Number	OE – Number	FEATURES	Ref	Old code	CODE	Description	OE – Number	OE – Number	FEATURES
1	-	06985	Stabilizer link	31306861483	-	Front Exc. XDrive	15	-	06997	Track rod-L	33326867537	-	Rear
2	-	07007	Stabilizer link	33506861482	-	Rear	16	-	06998	Track rod-R	33326867538	-	Rear
3	-	06986	Tie rod end-L	32106868536	32106868685	-	17	-	07000	Track rod-L	33326861115	-	Rear
4	-	06987	Tie rod end-R	32106868538	32106868687	-	18	-	07001	Track rod-R	33326861116	33326870536	Rear
5	-	06988	Axial joint	32106868688 Part of	32106868689 Part of	-	19	-	07002	Track rod-L	33326861125	-	Rear
6	-	06989	Control arm complete	31106861185	-	Upper	20	-	07003	Track rod-R	33326861126	-	Rear
7	-	06990	Bushing	31106861185 Part of	31106864374 Part of	Upper	21	-	07005	Track rod	33326861114	-	Rear
8	-	06993	Bushing	31106861161 Part of	31106861162 Part of	Lower	22	-	07696	STABILIZER LINK	31306861485	-	X Drive
9	-	06996	Bushing	31106861169 Part of	31106861170 Part of	Lower	23	-	07749	TRACK CONTROL ARM-LH	31106861165	-	X Drive ,Exc M550 X Drive
10	-	06919	Bushing	31106861169 Part of	31106861170 Part of	Lower	24	-	07750	TRACK CONTROL ARM-RH	31106861166	-	X Drive ,Exc M550 X Drive
11	-	06991	Track control arm-L	31106861161	-	Lower	25	-	07751	TRACK CONTROL ARM-LH	31106861181	-	X Drive ,Exc M550 X Drive
12	-	06992	Track control arm-R	31106861162	-	Lower	26	-	07752	TRACK CONTROL ARM-RH	31106861182	-	X Drive ,Exc M550 X Drive
13	-	06994	Track control arm-L	31106861177	-	Lower	27	-	07758	BALL JOINT (LOWER)	31106852536	-	X Drive ,Exc M550 X Drive
14	-	06995	Track control arm-R	31106861178	-	Lower							







Ref	Old code	CODE	Description	OE - Number	OE - Number	FEATURES	Ref	Old code	CODE	Description	OE - Number	OE - Number	FEATURES
1	BMW38	00115	Stabilizer link	33506781540	33556761000	"M10x1,5-131 mm (Rear EXC. DYNAMIC DRIVE)"	10	-	06942	Bushing	33326762732 Part of	33326770775 Part of	-
2	-	02664	Stabilizer link	33506768493	33506781537	"M12x1,5-158 mm (Rear DYNAMIC DRIVE)"	11	BMW56	00143	Track control arm	33320300946	33320398361	M10x1.5-212 mm (-> 10/2006)
3	-	01695	Stabilizer link-L	31306781541	31354014575	M10x1,5-332 mm (Front)	12	-	06953	Track control arm-L	31124046439	31126774829	-
4	-	01696	Stabilizer link-R	31306781542	31354014576	M10x1,5-332 mm (Front)	13	-	06954	Track control arm-R	31124046440	31126774830	-
5	-	01559	Tie rod end	32106774361	32106776946	M14x1,25-Female-M16x1,5-160 mm	14	BMW55-L	00141	Track control arm-L	31126755835	31126770121	M14x1.5-296.2 mm
6	-	01776	Axial joint	32106774347 Part of	32106777479 Part of	M16x1,5-M18x1,5-262 mm	15	BMW55-R	00142	Track control arm-R	31126755836	31126770122	M14x1.5-296.2 mm
7	-	06945	Bushing	31120305612 Part of	31126765922 Part of	-	16	-	05182	Track control arm-L	33326775083	-	09/2006 ->
8	-	06906	Bushing	31106770689 Part of	31106770690 Part of	-	17	-	05183	Track control arm-R	33326775084	-	09/2006 ->
9	-	06904	Bushing	33320300946 Part of	33320398361 Part of	(09/2006 -> (-> 10/2006)	18	BMW48-L	00128	Track control arm-L	33306772241	33326758141	M14x1.5-305 mm
							19	BMW48-R	00129	Track control arm-R	33306772242	33326767760	M14x1.5-305 mm
							20	-	02220	Track rod	33321090030	33321091620	165 mm (Rear)



BMW 6-SERIE COUPE (F13) (11/2010-->)
BMW 6-SERIE CABRIO (F12) (03/2011-->)
BMW 6-SERIE GRAND COUPE (F06) (09/2011-->)

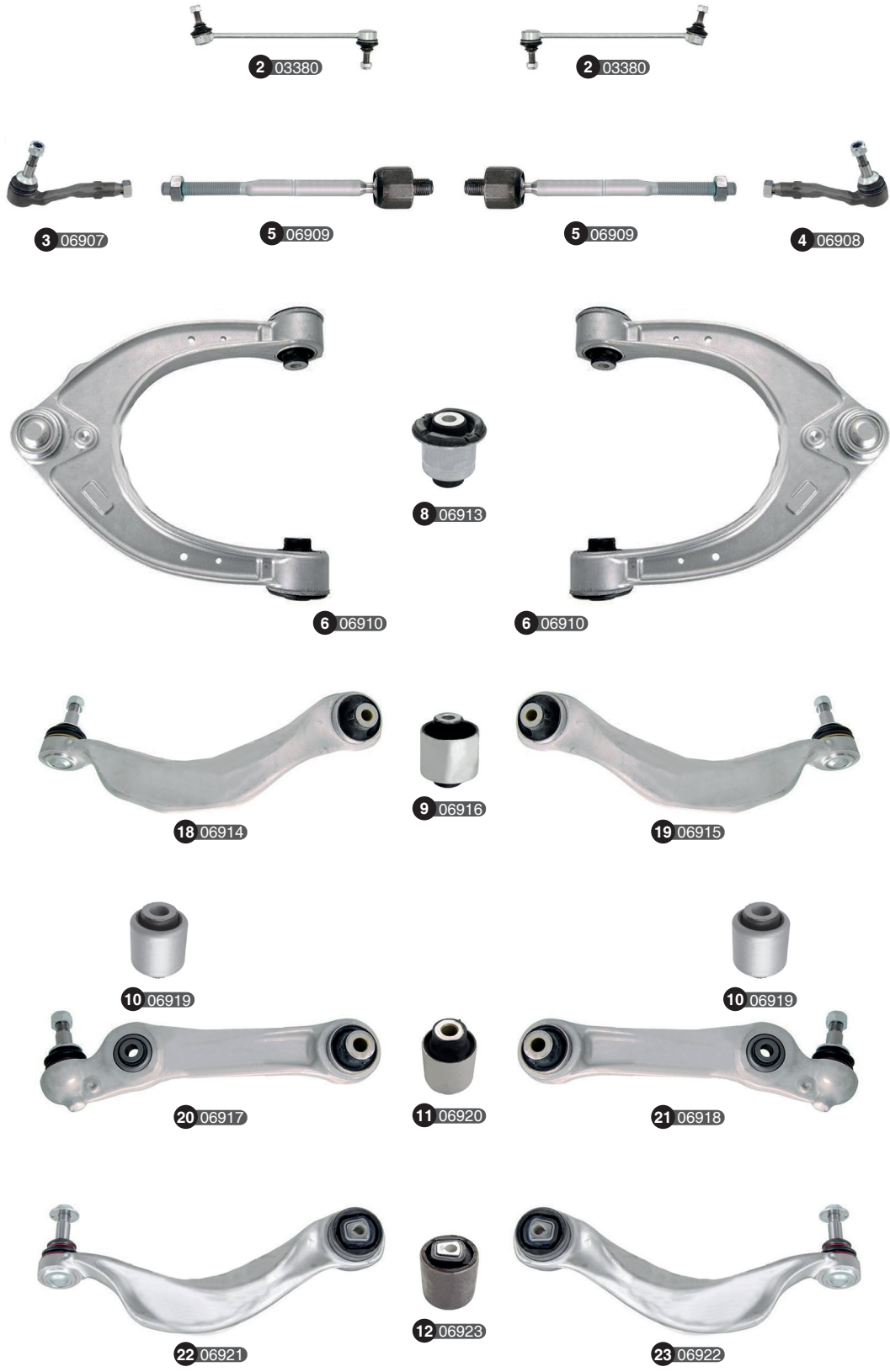



BMW 6-SERIE COUPE (F13) (11/2010-->)
BMW 6-SERIE CABRIO (F12) (03/2011-->)
BMW 6-SERIE GRAND COUPE (F06) (09/2011-->)





BMW 6-SERIE COUPE (F13) (11/2010-->)
BMW 6-SERIE CABRIO (F12) (03/2011-->)
BMW 6-SERIE GRAND COUPE (F06) (09/2011-->)

Ref	Old code	CODE	Description	OE – Number	OE – Number	FEATURES	Ref	Old code	CODE	Description	OE – Number	OE – Number	FEATURES
1	-	03617	Stabilizer link	33556777635	-	Rear EXC. Dynamic Drive	15	-	06930	Bushing	33324069283 Part of	-	-
2	-	03380	Stabilizer link	31356777319	-	Front	16	-	06932	Bushing	33326775680 Part of	-	-
3	-	06907	Tie rod end-L	32106784790	-	-	17	-	06931	Track control arm	33326775902	-	Rear
4	-	06908	Tie rod end-R	32106784796	-	-	18	-	06914	Track control arm-L	31126779871 Part of	-	Lower EXC. XDrive
5	-	06909	Axial joint	32106784716 Part of	32106784719 Part of	-	19	-	06915	Track control arm-R	31126775972	-	Lower EXC. XDrive
6	-	06910	Control arm complete	31126775967	-	Upper	20	-	06917	Track control arm-L	31126794203	-	Lower EXC. XDrive
7	-	06926	Ball joint	31126777753	-	Lower XDrive	21	-	06918	Track control arm-R	31126794204	-	Lower EXC. XDrive
8	-	06913	Bushing	31126775967 Part of	-	Upper	22	-	06921	Track control arm-L	31124083309	-	Lower XDrive
9	-	06916	Bushing	31126775971 Part of	31126775972 Part of	Lower EXC. XDrive	23	-	06922	Track control arm-R	31124083310	31126777734	Lower XDrive
10	-	06919	Bushing	31106861169 Part of	31106861170 Part of	"Lower EXC. XDrive Lower XDrive"	24	-	06924	Track control arm-L	31126777743	31126850605	Lower XDrive
11	-	06920	Bushing	31126791455	31126794203 Part of	Lower EXC. XDrive	25	-	06925	Track control arm-R	31126777744	31126850606	Lower XDrive
12	-	06923	Bushing	31126777653	-	Lower XDrive	26	-	06927	Track rod-L	33324069283	33326782135	Rear
13	-	06744	Bushing	31126777652	31126777739 Part of	Lower XDrive	27	-	06928	Track rod-R	33324069284	33326782136	Rear
14	-	06929	Bushing	33324069283 Part of	-	-	28	-	06934	Track rod	33326775683	-	Rear





1 01534



1 01534



2 01551



2 01551



3 00116



3 00116



Ref	Old code	CODE	Description	OE - Number	OE - Number	FEATURES	Ref	Old code	CODE	Description	OE - Number	OE - Number	FEATURES
1	-	01534	Stabilizer link	33321125665	-	50 mm (Rear)	3	BMW39	00116	Tie rod end	32211113447	-	M10x1,25-Male-M16x1,5-82 mm
2	-	01551	Stabilizer link	33551126932	-	100 mm (Rear)							



Ref	Old code	CODE	Description	OE - Number	OE - Number	FEATURES	Ref	Old code	CODE	Description	OE - Number	OE - Number	FEATURES
1	BMW03	00080	Stabilizer link	31351124380	31351127194	M10x1,5-239 mm (Front)	9	BMW47-L	00126	Track control arm-L	31121133237	31121139987	M14x1,5-323 mm (ALUMINIUM)
2	-	01534	Stabilizer link	33321125665	33321123463	50 mm (Rear)	10	BMW47-R	00127	Track control arm-R	31121133238	31121139988	M14x1,5-323 mm (ALUMINIUM)
3	-	02204	Stabilizer link	33551135307	-	60 mm (Rear)	11	-	01522	Track control arm-L	31121124401	31121131587	M14x1,5-325 mm (STEEL)
4	BMW16	00093	Tie rod end	32211127918	32211130001	Inner	12	-	01521	Track control arm-R	31121124402	31121131582	M14x1,5-325 mm (STEEL)
5	BMW42	00119	Tie rod end	32211114842	32211127917	M10x1,25-Male-M14x1,5-88 mm	13	-	01548	Track control arm-L	31121130089	31121139999	-
6	-	02221	Bushing	31121136605	31121136607	-	14	-	01549	Track control arm-R	31121130090	31121130598	-
7	-	06789	Bushing	31121124622	-	-							
8	-	06906	Bushing	31106770689	31121139238	-							

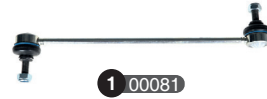
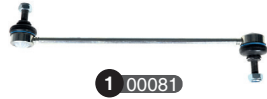

9 00136





Ref	Old code	CODE	Description	OE - Number	OE - Number	FEATURES	Ref	Old code	CODE	Description	OE - Number	OE - Number	FEATURES
1	BMW04	00081	Stabilizer link	31351091496	31351095695	M10x1,5-308 mm (Front)	9	BMW52	00136	Track control arm	33321090745	33321097264	M10x1,5-211,5 mm
2	BMW05	00082	Stabilizer link	33551091497	33551095696	M10x1,5-75 mm (Rear)	10	-	02199	Track control arm-L	31121142087	-	M14x1,5-324 mm
3	-	01482	Tie rod end-L	32211141345	-	M12x1,5-Female-M16x1,5-220 mm	11	-	02200	Track control arm-R	31121142088	-	M14x1,5-324 mm
4	-	01483	Tie rod end-R	32211141346	-	M12x1,5-Female-M16x1,5-220 mm	12	-	02469	Track control arm-L	31121141721	31121141723	M14x1,5-437,5 mm
5	-	02225	Bushing	31121141752	31120006482	-	13	-	02470	Track control arm-R	31121141722	31121141724	M14x1,5-437,5 mm
6	-	02548	Bushing	33321090102	-	-	14	-	02550	Track control arm-L	33321090905	33326770059	-
7	-	06906	Bushing	31106770689	31121139238	-	15	-	02551	Track control arm-R	33321090906	33326770060	-
8	-	06521	Bushing	33326768791 Part of	-	-	16	-	02220	Track rod	33321090030	33321091620	165 mm (Rear)





20 02220



20 02220



1 01671



1 01671



2 01859



2 01859



Ref	Old code	CODE	Description	OE - Number	OE - Number	FEATURES	Ref	Old code	CODE	Description	OE - Number	OE - Number	FEATURES
1	-	01671	Stabilizer link	33506781538	33556757460	Rear EXCL. DYNAMIC DRIVE	10	-	06904	Bushing	33320300946 Part of	33320398361 Part of	"(09/2006 ->) (->10/2006)"
2	-	01859	Stabilizer link	33506781539	33556753770	"M12x1,25-19 25-206.5 mm (Rear DYNAMIC DRIVE)"	11	BMW56	00143	Track control arm	33320300946	33320398361	M10x1.5-212 mm (-> 10/2006)
3	-	01669	Stabilizer link-L	31306781545	31356753767	M10x1,25-426 mm (Front)	12	BMW48-L	00128	Track control arm-L	33306772241	33326767759	M14x1.5-305 mm
4	-	01670	Stabilizer link-R	31306781546	31356753768	M10x1,25-426 mm (Front)	13	BMW48-R	00129	Track control arm-R	33306772242	33326767760	M14x1.5-305 mm
5	-	01559	Tie rod end	32106774361	32106776946	M14x1,25-Female-M16x1,5-160 mm	14	BMW54-L	00139	Track control arm-L	31124026453	31124046441	M14x1.5-424 mm
6	-	01560	Axial joint	32106774360 Part of	32106777268 Part of	M16x1,5-M18x1,5-230 mm	15	BMW54-R	00140	Track control arm-R	31124026454	31124046442	M14x1.5-424 mm
7	-	06938	Bushing	31124026453 Part of	31124026454 Part of	-	16	BMW55-L	00141	Track control arm-L	31126755835	31126770121	M14x1.5-296.2 mm
8	-	06942	Bushing	33326762732 Part of	33326770775 Part of	-	17	BMW55-R	00142	Track control arm-R	31126755836	31126770122	M14x1.5-296.2 mm
9	-	06906	Bushing	31106770689 Part of	31106770690 Part of	-	18	-	05182	Track control arm-L	33326775083	-	09/2006 ->
							19	-	05183	Track control arm-R	33326775084	-	09/2006 ->
							20	-	02220	Track rod	33321090030	33321091620	165 mm (Rear)



BMW 7-SERIE (F01, F02) (10/2008-12/2015)
BMW 7-SERIE HYBRID (F04) (10/2010-12/2015)





BMW 7-SERIE (F01, F02) (10/2008-12/2015)
BMW 7-SERIE HYBRID (F04) (10/2010-12/2015)

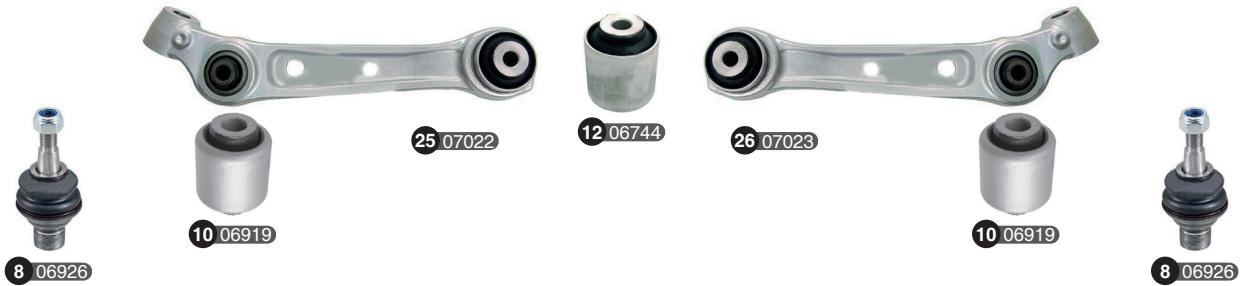

BMW 7-SERIE (F01, F02) (10/2008-12/2015)
BMW 7-SERIE HYBRID (F04) (10/2010-12/2015)

Ref	Old code	CODE	Description	OE – Number	OE – Number	FEATURES	Ref	Old code	CODE	Description	OE – Number	OE – Number	FEATURES
1	-	03617	Stabilizer link	33556777635	-	Rear EXC. Dynamic Drive	17	-	07019	Bushing	31126775963 Part of	31126775980 PARTT OF	Lower EXC. IX - DX - XDrive - Hybrid
2	-	03380	Stabilizer link	31356777319	-	Front	18	-	06931	Track control arm	33326775902	-	Rear
3	-	03381	Stabilizer link	37106775189	-	Rear Dynamic Drive	19	-	07013	Track control arm-L	31124083311	31126775659	Lower EXC. IX - DX - XDrive - Hybrid
4	-	06907	Tie rod end-L	32106784790	-	-	20	-	07014	Track control arm-R	31124083312	31126775960	Lower EXC. IX - DX - XDrive - Hybrid
5	-	06908	Tie rod end-R	32106784796	-	-	21	-	07016	Track control arm-L	31126775963	31126798107	Lower EXC. IX - DX - XDrive - Hybrid
6	-	06909	Axial joint	32106784716 Part of	32106784719 Part of	-	22	-	07017	Track control arm-R	31126775964	31126798108	Lower EXC. IX - DX - XDrive - Hybrid
7	-	06910	Control arm complete	31126775967	-	Upper	23	-	07020	Track control arm-L	31124081431	31126777729	Lower IX - DX - XDrive - Hybrid
8	-	06926	Ball joint	31126777753	-	Lower IX - DX - XDrive - Hybrid	24	-	07021	Track control arm-R	31124081432	31126777730	Lower IX - DX - XDrive - Hybrid
9	-	06913	Bushing	31126775967 Part of	-	Upper	25	-	07022	Track control arm-L	31126777739	-	Lower IX - DX - XDrive - Hybrid
10	-	06919	Bushing	31106861169 Part of	31106861170 Part of	"Lower EXC. IX - DX - XDrive - Hybrid Lower IX - DX - XDrive - Hybrid"	26	-	07023	Track control arm-R	31126777740	-	Lower IX - DX - XDrive - Hybrid
11	-	06923	Bushing	31126777653	-	Lower IX - DX - XDrive - Hybrid	27	-	06927	Track rod-L	33324069283	33326782135	Rear 07/2012 ->
12	-	06744	Bushing	31126777652	31126777739 Part of	Lower IX - DX - XDrive - Hybrid	28	-	06928	Track rod-R	33324069284	33326782136	Rear 07/2012 ->
13	-	06929	Bushing	33324069283 Part of	-	-	29	-	06934	Track rod	33326775683	-	Rear
14	-	06930	Bushing	33324069283 Part of	-	-	30	-	07029	Track rod-L	33324069467	33326782131	Rear -> 07/2012
15	-	06932	Bushing	33326775680 Part of	-	-	31	-	07030	Track rod-R	33324069468	33326782132	Rear -> 07/2012
16	-	07015	Bushing	31126775145	-	Lower EXC. IX - DX - XDrive - Hybrid							







23 07754



9 07041



24 07755



10 06919



10 06919



27 07758



25 07756



11 06996



26 07757



27 07758



16 06997



17 06998



18 07000



19 07001



20 07002



21 07003



22 07005



2 07007



2 07007



Ref	Old code	CODE	Description	OE – Number	OE – Number	FEATURES	Ref	Old code	CODE	Description	OE – Number	OE – Number	FEATURES
1	-	06985	Stabilizer link	31306861483	-	Exc. X Drive Front	15	-	07043	Track control arm-R	31106861170	-	Lower
2	-	07007	Stabilizer link	33506861482	-	Rear Dynamic Drive	16	-	06997	Track rod-L	33326867537	-	Rear
3	-	07696	STABILIZER LINK	31306861485	-	X Drive	17	-	06998	Track rod-R	33326867538	-	Rear
4	-	06986	Tie rod end-L	32106868536	32106868685	-	18	-	07000	Track rod-L	33326861115	33326870535	Rear
5	-	06987	Tie rod end-R	32106868538	32106868687	-	19	-	07001	Track rod-R	33326861116	33326870536	Rear
6	-	06988	Axial joint	32106868688 Part of	32106868689 Part of	-	20	-	07002	Track rod-L	33326861125	-	Rear
7	-	07038	Control arm complete	31106868530	-	Upper	21	-	07003	Track rod-R	33326861126	-	Rear
8	-	06990	Bushing	31106861185 Part of	31106864374 Part of	Upper	22	-	07005	Track rod	33326861114	-	Rear
9	-	07041	Bushing	31106861151 Part of	-	Lower	23	-	07754	TRACK CONTROL ARM-LH	31106861157	-	X Drive
10	-	06919	Bushing	31106861169 Part of	31106861170 Part of	Lower	24	-	07755	TRACK CONTROL ARM-RH	31106861158	-	X Drive
11	-	06996	Bushing	31106861169 Part of	31106861170 Part of	Lower	25	-	07756	TRACK CONTROL ARM-LH	31106861173	-	X Drive
12	-	07039	Track control arm-L	31106861151	-	Lower	26	-	07757	TRACK CONTROL ARM-RH	31106861174	-	X Drive
13	-	07040	Track control arm-R	31106861152	-	Lower	27	-	07758	BALL JOINT (LOWER)	31106852536	-	X Drive
14	-	07042	Track control arm-L	31106861169	-	Lower							





Ref	Old code	CODE	Description	OE - Number	OE - Number	FEATURES	Ref	Old code	CODE	Description	OE - Number	OE - Number	FEATURES
1	BMW03	00080	Stabilizer link	31351124380	31351127194	M10x1,5-239 mm (Front)	4	-	02221	Bushing	31121136605	31121136607	-
2	BMW16	00093	Tie rod end	32211127918	32211130001	Inner	5	-	01548	Track control arm-L	31121130089	31121139999	-
3	BMW42 (MCD18)	00119	Tie rod end	32211114842	32211127917	M10x1,25-Male-M14x1,5-88 mm	6	-	01549	Track control arm-R	31121130090	31121130598	-

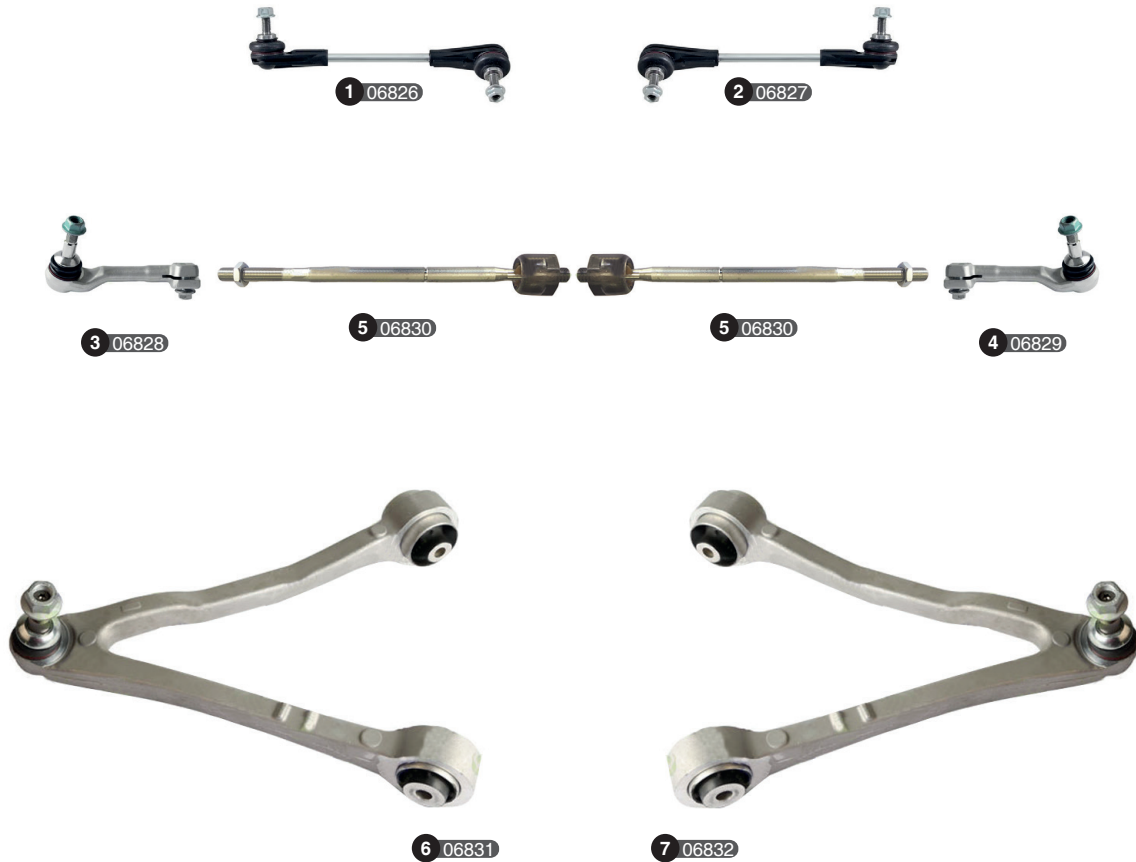

Ref	Old code	CODE	Description	OE - Number	OE - Number	FEATURES	Ref	Old code	CODE	Description	OE - Number	OE - Number	FEATURES
1	-	06826	Stabilizer link-L	31306862857	-	Front	5	-	06830	Axial joint	32216851409 Part of	32216851410 Part of	-
2	-	06827	Stabilizer link-R	31306862858	-	Front	6	-	06831	Control arm complete-L	31106863739	-	-
3	-	06828	Tie rod end-L	32106851411	-	-	7	-	06832	Control arm complete-R	31106863740	-	-
4	-	06829	Tie rod end-R	32106851412	-	-							





Ref	Old code	CODE	Description	OE - Number	OE - Number	FEATURES	Ref	Old code	CODE	Description	OE - Number	OE - Number	FEATURES
1	-	03597	Stabilizer link-L	33506785607	-	M10x1,25-135,5 mm (Rear)	14	-	06811	Ball joint	31126768988	-	xDrive
							15	-	06797	Bushing	31120393540	31120398350	sDrive
2	-	03598	Stabilizer link-R	33506785608	-	M10x1,25-135,5 mm (Rear)	16	-	06800	Bushing	31126770849 Part of	31126770850 Part of	sDrive
							17	-	06810	Bushing	31126768991	31126768989 Part of	xDrive
3	-	02046	Stabilizer link-L	31356765933	-	M10x1,5-290 mm(Front sDrive)	18	-	06812	Bushing	31120410791	31126768818	xDrive
							19	-	02226	Bushing	33326763092	-	-
4	-	02047	Stabilizer link-R	31356765934	-	M10x1,5-290 mm(Front sDrive)	20	-	02228	Bushing	33326765535	33326765425 Part of	-
5	-	06804	Stabilizer link-L	31356768771	-	Front xDrive	21	-	02227	Bushing	33326765534	-	-
6	-	06805	Stabilizer link-R	31356768772	-	Front xDrive	22	-	06818	Bushing	33326767190	33326763473 Part of	-
							23	-	06809	Track control arm	31126768989	-	xDrive
7	-	02201	Tie rod end-L	32106765089	-	"M14x1.5-M14x1.5-139.5 mm (sDrive TRW STEERING) (sDrive ZF STEERING)"	24	-	03807	Track control arm-L	00029001751501	31126768983	xDrive
							25	-	03808	Track control arm-R	00029001851501	31126768984	xDrive
							26	-	06795	Track control arm-L	31122405861	31124036269	sDrive
8	-	02202	Tie rod end-R	32106765090	-	"M14x1.5-M14x1.5-139.5 mm (sDrive TRW STEERING) (sDrive ZF STEERING)"	27	-	06796	Track control arm-R	31122405862	31124036270	sDrive
							28	-	06798	Track control arm-L	31122405859	31126763699	sDrive
9	-	06806	Tie rod end-L	32106769073	32106793623	xDrive	29	-	06799	Track control arm-R	31122405860	31126763700	sDrive
10	-	06807	Tie rod end-R	32106769074	32106793624	xDrive	30	-	06813	Track rod	33326765425	-	-> 11/2009 Upper
							31	-	06814	Track rod-L	33326782237	-	Upper 12/2009 ->
11	-	02203	Axial joint	32216762243 Part of	32216762244 Part of	"M14x1,5-M18x1,5-246 mm (sDrive TRW STEERING)"	32	-	06815	Track rod-R	33326782238	-	Upper 12/2009 ->
							33	-	06817	Track rod	33326782168	-	Upper
12	-	06794	Axial joint	32106765235 Part of	32106765236 Part of	sDrive ZF Steering	34	-	06819	Track rod	33326763471	-	-
13	-	06808	Axial joint	32106768879 Part of	32106768880 Part of	xDrive							



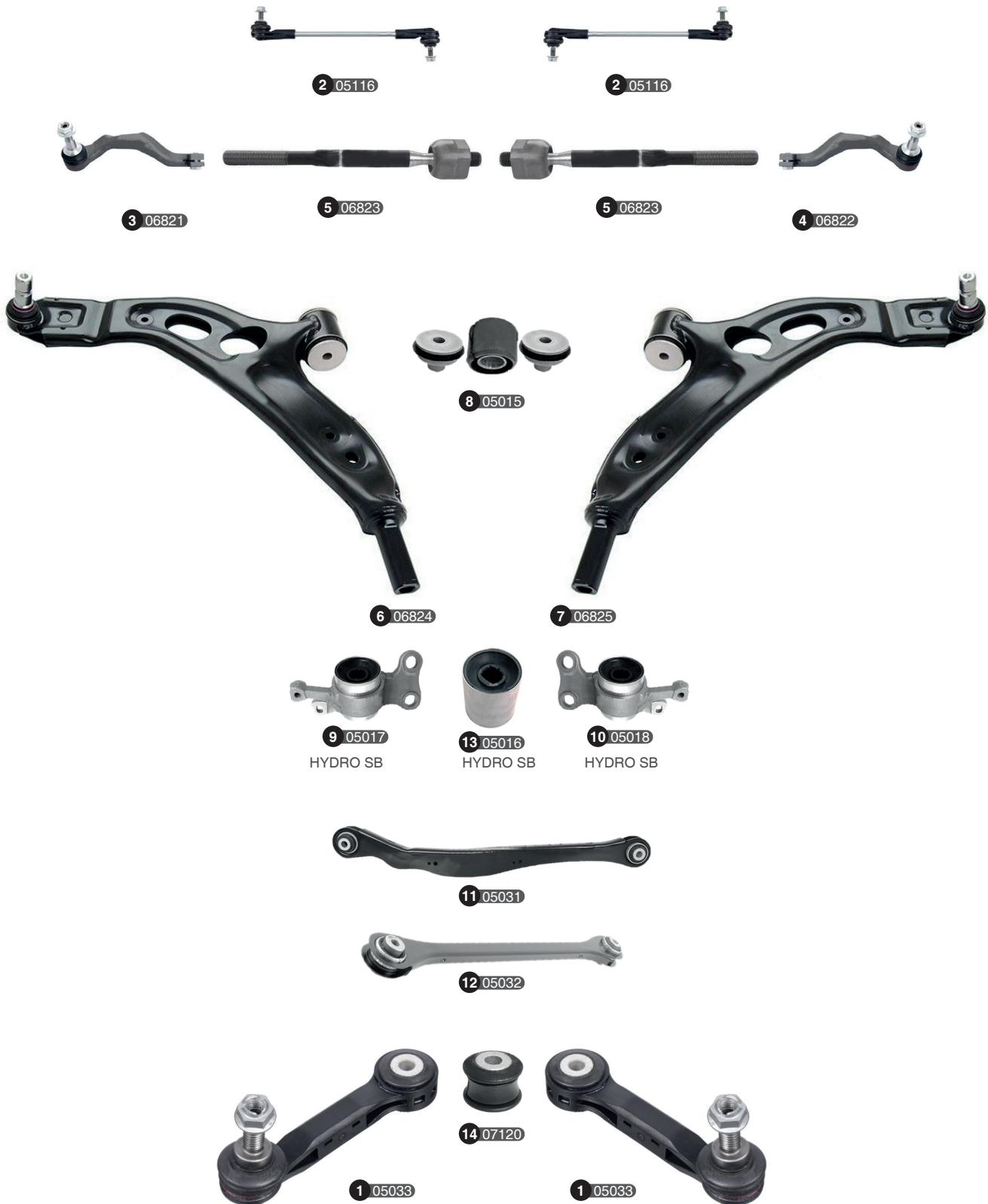

HYDRO SB

HYDRO SB

HYDRO SB





Ref	Old code	CODE	Description	OE – Number	OE – Number	FEATURES	Ref	Old code	CODE	Description	OE – Number	OE – Number	FEATURES
1	-	05033	Stabilizer link	33506862865	-	Rear	8	-	05015	Bushing (KIT)	31126850397 Part of	31126850398 Part of	KIT
2	-	05116	Stabilizer link	31306862864	-	Front	9	-	05017	Bushing-L	31126850403	31126874341	-
3	-	06821	Tie rod end-L	32106869424	-	-	10	-	05018	Bushing-R	31126850404	31126874342	-
4	-	06822	Tie rod end-R	32106869425	-	-	11	-	05031	Track rod	33326851563	33326870773	Upper
5	-	06823	Axial joint	32106867404 Part of	32106867405 Part of	-	12	-	05032	Track rod	33326851569	-	Lower
6	-	06824	Control arm complete-L	31122785113	31126851203	-	13	-	05016	Bushing	31126874343	-	-
7	-	06825	Control arm complete-R	31122785114	31126851204	-	14	-	07120	Bushing	33506862865 PART OF	-	-



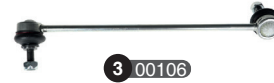

--> 12/2006



12/2006 -->



Ref	Old code	CODE	Description	OE – Number	OE – Number	FEATURES	Ref	Old code	CODE	Description	OE – Number	OE – Number	FEATURES
1	BMW34	00110	Stabilizer link	33503413197	33503414297	M10x1,5-95 mm (Rear)	10	-	02027	Bushing	31121096372	31126769715	Rear Axle(->12/2006) (12/2006->)
2	BMW31-L	00105	Stabilizer link-L	31303413201	31303414299	M10x1,5-299,5 mm (Front)	11	-	06789	Bushing	31121124622	-	-
3	BMW31-R	00106	Stabilizer link-R	31303413202	31303414300	M10x1,5-299,5 mm (Front)	12	-	06759	Track control arm	33303411651	33321092237	-
4	-	01773	Tie rod end	32303418202	32413413476	-	13	-	06745	Track control arm-L	31103412137	-	-> 12/2006
5	-	01706	Axial joint	32103412798	32103418204	M18x1,5- M14x1,5-220 mm	14	-	06746	Track control arm-R	31103412138	-	-> 12/2006
6	-	01710	Ball joint	31103412726	31103418341	Lower -> 12/2006	15	-	06748	Track control arm-L	31100363477	31103443127	12/2006 ->
7	-	06747	Ball joint	31103438623	-	12/2006 ->	16	-	06749	Track control arm-R	31100363478	31103443128	12/2006 ->
8	-	06760	Bushing	33321136311	33326471828	-	17	-	06750	Track control arm-L	31103412135	31103415027	-
9	-	06761	Bushing	33321092248	33321138383	-	18	-	06751	Track control arm-R	31103412136	31103415028	-







Ref	Old code	CODE	Description	OE - Number	OE - Number	FEATURES	Ref	Old code	CODE	Description	OE - Number	OE - Number	FEATURES
1	-	03618	Stabilizer link	33556790324	3355679224	Rear	13	-	06778	Bushing	33326756249	33326792553	-
2	-	06763	Stabilizer link-L	31306787163	-	Front	14	-	06787	Track control arm	33326795812	-	-
3	-	06764	Stabilizer link-R	31306787164	-	Front	15	-	06768	Track control arm-L	31106787673	-	-
4	-	06765	Tie rod end	32106792674	-	-	16	-	06769	Track control arm-R	31106787674	-	-
5	-	06766	Axial joint	32106787472 Part of	-	-	17	-	06771	Track control arm-L	31126787669	-	-
6	-	06767	Ball joint	31106787665	-	-	18	-	06772	Track control arm-R	31126787670	-	-
7	-	06770	Bushing	31106786951	-	-	19	-	06774	Track rod	33306786991	-	Upper
8	-	06773	Bushing	31106786959	31126852991 Part of	-	20	-	06777	Track rod	33326786981	-	Upper
9	-	06775	Bushing	33306786994	33306786991 Part of	-	21	-	06779	Track rod-L	33326788549	-	Upper
10	-	06776	Bushing	33306786993	-	-	22	-	06780	Track rod-R	33326788550	-	Upper
11	-	06786	Bushing	33306786980	-	-	23	-	06785	Track rod	33326786978	-	-
12	-	06788	Bushing	33326795812	-	-	24	-	07730	Bushing	33326790493	-	-

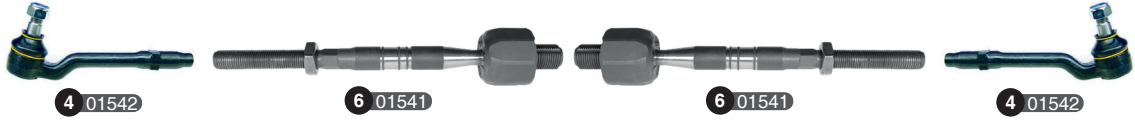



18 02220



18 02220



1 00109



1 00109



Ref	Old code	CODE	Description	OE - Number	OE - Number	FEATURES	Ref	Old code	CODE	Description	OE - Number	OE - Number	FEATURES
1	BMW33	00109	Stabilizer link	33551096735	-	M12x1,5-67 mm (Rear)	9	-	02705	Control arm complete-L	33321095411	33326768273	Rear
2	BMW32-L	00107	Stabilizer link-L	31356750703	-	M12x1,5-358 mm (Front)	10	-	02706	Control arm complete-R	33321095412	33326768274	Rear
3	BMW32-R	00108	Stabilizer link-R	31356750704	-	M12x1,5-358 mm (Front)	11	-	01544	Ball joint	31121096425	31126756491	-
4	-	01542	Tie rod end	32211096327	-	"M14x1,5-Male-M14x1,5-195 mm (-> 10/2003)"	12	-	01603	Ball joint	33321095411 Part of	33321095411 Part of	Lower
							13	-	02027	Bushing	31121096372	31126769715	Rear Axle
							14	-	06789	Bushing	31121124622	-	-
5	-	01865	Tie rod end	32216760354	32106774335	"M14x1,5-Female-M14x1,5-195mm (10/2003->)"	15	-	06790	Bushing	33326774796 Part of	-	-
							16	-	06791	Bushing	33326470859 Part of	33326470860 Part of	-
6	-	01541	Axial joint	32216751277	32106774336	"M14x1,5-M18x1,5-220 mm (-> 10/2003) (10/2003 ->)"	17	-	01545	Track control arm	33321095414	33326768269	-
							18	-	02220	Track rod	33321090030	33321091620	165 mm (Rear)
7	-	01880	Control arm complete-L	31121096169	31126769717	Lower	19	-	02808	Track control arm complete-L	31121096315	31126760275	M14x1.5-297 mm
8	-	01881	Control arm complete-R	31121096170	31126769718	Lower	20	-	02809	Track control arm complete-R	31121096316	31126760276	M14x1.5-297 mm





Ref	Old code	CODE	Description	OE - Number	OE - Number	FEATURES	Ref	Old code	CODE	Description	OE - Number	OE - Number	FEATURES
1	-	01939	Stabilizer link	33556771937	33556857626	M12x1,5-160,2 mm (Rear)	11	-	06734	Control arm complete-R	31126863786	-	Upper
2	-	01937	Stabilizer link-L	31356773023	31356857623	"M12x1,5-248,5 mm (Front EXC. DYNAMIC DRIVE)"	12	-	06735	Bushing	21126863787	31126863333 Part of	Upper
							13	-	06738	Bushing	31126851693	-	Exc. Active Steering
3	-	01938	Stabilizer link-R	31356773024	31356857624	"M12x1,5-248,5 mm (Front EXC. DYNAMIC DRIVE)"	14	-	06741	Bushing	31126863171	-	Active Steering
							15	-	06719	Bushing	31106771897	31126855509	Lower
							16	-	06744	Bushing	31126777652	-	Lower
							17	-	06721	Bushing	33306779517	-	-
4	-	01934	Stabilizer link-L	37116771929	37116857627	"M12x1,5-247 mm (Front DYNAMIC DRIVE)"	18	-	06736	Track control arm-L	31126851691	-	Lower EXC. Active Steering
							19	-	06737	Track control arm-R	31126851692	-	Lower EXC. Active Steering
5	-	01935	Stabilizer link-R	37116771930	37116857628	"M12x1,5-247 mm (Front DYNAMIC DRIVE)"	20	-	06739	Track control arm-L	31126863169	-	Lower Active Steering
							21	-	06740	Track control arm-R	31126863170	-	Lower Active Steering
6	-	06728	Tie rod end-L	32106858736	32106863858	"EXC. active Steering Active Steering"	22	-	06742	Track control arm-L	31126864821	-	Lower
							23	-	06743	Track control arm-R	31126864822	-	Lower
7	-	06729	Tie rod end-R	32106858738	32106863860	"EXC. active Steering Active Steering"	24	-	05180	Track control arm-L	33324046917	33326779387	-
8	-	06731	Axial joint	32106858735 Part of	32106858737 Part of	Exc. Active Steering	25	-	05181	Track control arm-R	33324046918	33326779388	-
9	-	06732	Axial joint	32106863857 Part of	32106863859 Part of	Active Steering	26	-	07312	Track control arm-L	33326796001	-	-
10	-	06733	Control arm complete-L	31126863785	-	Upper	27	-	07313	Track control arm-R	33326796002	-	-
							28	-	06724	Track rod	3332677476	-	-





Ref	Old code	CODE	Description	OE - Number	OE - Number	FEATURES	Ref	Old code	CODE	Description	OE - Number	OE - Number	FEATURES
1	-	01939	Stabilizer link	33556771937	33556857626	M12x1,5-160,2 mm	12	-	06719	Bushing	31106771897	31126855509	Lower
2	-	01934	Stabilizer link-L	37116771929	37116857627	M12x1,5-247 mm	13	-	06720	Bushing	31106771194	-	Lower
3	-	01935	Stabilizer link-R	37116771930	37116857628	M12x1,5-247 mm	14	-	06721	Bushing	33306779517	-	-
4	-	01937	Stabilizer link-L	31356773023	31356857623	M12x1,5-248,5 mm	15	-	05178	Track control arm-L	33326770969	-	-
5	-	01938	Stabilizer link-R	31356773024	31356857624	M12x1,5-248,5 mm	16	-	05179	Track control arm-R	33326770970	-	-
6	-	02568	Tie rod end	32106780984	32106793497	-	17	-	05180	Track control arm-L	33324046917	33326779387	-
7	-	01936	Axial joint	32106780985	32106793496	M14x1,5- M18x1,5-219,5 mm	18	-	05181	Track control arm-R	33324046918	33326779388	-
8	-	06711	Control arm complete-L	31126776417	-	Upper	19	-	06714	Track control arm-L	31126773949	-	Lower
9	-	06712	Control arm complete-R	31126776418	-	Upper	20	-	06715	Track control arm-R	31126773950	-	Lower
10	-	06713	Bushing	31126771199	31126772995 Part of	Upper	21	-	06717	Track control arm-L	31126771893	-	Lower
11	-	06716	Bushing	31106778015	-	Lower	22	-	06718	Track control arm-R	31126771894	-	Lower
							23	-	06724	Track rod	3332677476	-	-





Ref	Old code	CODE	Description	OE - Number	OE - Number	FEATURES	Ref	Old code	CODE	Description	OE - Number	OE - Number	FEATURES
1	-	01939	Stabilizer link	33556771937	33556857626	M12x1,5-160,2 mm (Rear)	11	-	06734	Control arm complete-R	31126863786	-	Upper
2	-	01937	Stabilizer link-L	31356773023	31356857623	"M12x1,5-248,5 mm (Front EXC. DYNAMIC DRIVE)"	12	-	06735	Bushing	21126863787	31126863333 Part of	Upper
							13	-	06738	Bushing	31126851693	-	Exc. Active Steering
3	-	01938	Stabilizer link-R	31356773024	31356857624	"M12x1,5-248,5 mm (Front EXC. DYNAMIC DRIVE)"	14	-	06741	Bushing	31126863171	-	Active Steering
							15	-	06719	Bushing	31106771897	31126855509	Lower
							16	-	06721	Bushing	33306779517	-	-
							17	-	06744	Bushing	31126777652	-	Lower
4	-	01934	Stabilizer link-L	37116771929	37116857627	"M12x1,5-247 mm (Front DYNAMIC DRIVE)"	18	-	06736	Track control arm-L	31126851691	-	Lower EXC. Active Steering
							19	-	06737	Track control arm-R	31126851692	-	Lower EXC. Active Steering
5	-	01935	Stabilizer link-R	37116771930	37116857628	"M12x1,5-247 mm (Front DYNAMIC DRIVE)"	20	-	06739	Track control arm-L	31126863169	-	Lower Active Steering
							21	-	06740	Track control arm-R	31126863170	-	Lower Active Steering
6	-	06728	Tie rod end-L	32106858736	32106863858	"EXC. active Steering Active Steering"	22	-	06742	Track control arm-L	31126864821	-	Lower
							23	-	06743	Track control arm-R	31126864822	-	Lower
7	-	06729	Tie rod end-R	32106858738	32106863860	"EXC. active Steering Active Steering"	24	-	05180	Track control arm-L	33324046917	33326779387	-
8	-	06731	Axial joint	32106858735 Part of	32106858737 Part of	Exc. Active Steering	25	-	05181	Track control arm-R	33324046918	33326779388	-
9	-	06732	Axial joint	32106863857 Part of	32106863859 Part of	Active Steering	26	-	07312	Track control arm-L	33326796001	-	-
10	-	06733	Control arm complete-L	31126863785	-	Upper	27	-	07313	Track control arm-R	33326796002	-	-
							28	-	06724	Track rod	3332677476	-	-



Ref	Old code	CODE	Description	OE - Number	OE - Number	FEATURES	Ref	Old code	CODE	Description	OE - Number	OE - Number	FEATURES
1	BMW01	00078	Stabilizer link	31351091764	31351127689	M10x1,5-66 mm (Front)	5	-	01509	Control arm complete-L	31121127725	-	320,7 mm (-> 10/1989)
2	-	01551	Stabilizer link	33551126932	33551124375	100 mm (Rear)	6	-	01508	Control arm complete-R	31121127726	-	320,7 mm (-> 10/1989)
3	BMW10	00087	Tie rod end	32111126757	32111126757	M10x1.25-M14x1.5-200 mm	7	BMW13	00090	Ball joint	31121126254	-	M12x1,5 (-> 10/1989)
4	BMW11-L	00088	Axial joint-L	32111127124	-	M14x1,5-M18x1,5-230 mm	8	BMW20	00098	Ball joint	31121126253	-	M14x1,5 (-> 10/1989)
							9	-	02254	Bushing-L	31121139789	-	-> 10/1989
							10	-	02255	Bushing-R	31121139790	-	-> 10/1989



Ref	Old code	CODE	Description	OE - Number	OE - Number	FEATURES	Ref	Old code	CODE	Description	OE - Number	OE - Number	FEATURES
1	BMW01	00078	Stabilizer link	31351091764	31351127689	M10x1,5-66 mm (Front EXC. M3)	6	BMW18	00096	Axial joint	32111139315 Part of	32111139316 Part of	M14x1,5- M18x1,5-206 mm
2	-	02662	Stabilizer link	31352227203	LR002876	M10x1,5-229 mm (Front M3)	7	BMW60-L	00146	Control arm complete-L	31121094275	31121136529R	320,6 mm (Reinforced)
3	-	02204	Stabilizer link	33551135307	-	60 mm (Rear)	8	BMW60-R	00147	Control arm complete-R	31121094276	31121094276R	320,6 mm (Reinforced)
4	BMW17-L	00094	Tie rod end-L	32111139313	-	M10x1,5-Female- M14x1,5-214 mm	9	BMW19	00097	Ball joint	31121096685	31121140398	M12x1,5
5	BMW17-R	00095	Tie rod end-R	32111139314	-	M10x1,25-Female- M14x1,5-214 mm	10	-	06802	Ball joint	31121139131	-	-
							11	-	06803	Ball joint	31121096685 Part of	31121140398 Part of	Reinforced
							12	-	02253	Bushing-L	31121136531	-	-
							13	-	02252	Bushing-R	31121136532	-	-



Ref	Old code	CODE	Description	OE - Number	OE - Number	FEATURES	Ref	Old code	CODE	Description	OE - Number	OE - Number	FEATURES
1	-	06801	Stabilizer link	33552282182	33552283743	Rear	8	-	06800	Bushing	31126770849 Part of	31126770850 Part of	-
2	-	02046	Stabilizer link-L	31356765933	-	M10x1,5-290 mm (Front)	9	-	06760	Bushing	33321136311	33326471828	-
3	-	02047	Stabilizer link-R	31356765934	-	M10x1,5-290 mm (Front)	10	-	06761	Bushing	33321092248	33321138383	-
4	-	02201	Tie rod end-L	32106765089	32106767781	M14x1.5- M14x1.5-139.5 mm	11	-	06759	Track control arm	33303411651	33321092237	-
5	-	02202	Tie rod end-R	32106765090	32106767782	M14x1.5- M14x1.5-139.5 mm	12	-	06795	Track control arm-L	31122405861	31124036269	-
6	-	06794	Axial joint	32106765235 Part of	32106765236 Part of	-	13	-	06796	Track control arm-R	31122405862	31124036270	-
7	-	06797	Bushing	31120393540	31120398350	-	14	-	06798	Track control arm-L	31122405859	31126763699	-
							15	-	06799	Track control arm-R	31122405860	31126763700	-





Ref	Old code	CODE	Description	OE - Number	OE - Number	FEATURES	Ref	Old code	CODE	Description	OE - Number	OE - Number	FEATURES
1	BMW02	00079	Stabilizer link	31351095694	31356780847	M10x1,5-272 mm (Front)	8	-	06300	Control arm complete-L	31122282121 Part of	31122341297 Part of	With sb and reinforced
2	-	06801	Stabilizer link	33552282182	33552283743	Rear	9	-	06301	Control arm complete-R	31122282122 Part of	31122341828 Part of	With sb and reinforced
3	BMW57-L	00144	Tie rod end-L	32111095957	32106774220	-	10	-	06760	Bushing	33321136311	33326471828	-
4	BMW57-R	00145	Tie rod end-R	32111095958	32106774221	-	11	-	06761	Bushing	33321092248	33321138383	-
5	BMW37	00114	Axial joint	32106774222 Part of	32106774223 Part of	M14x1,5- M18x1,5-205 mm	12	-	02250	Bushing-L	31126756063	-	-
6	BMW46-L	00124	Control arm complete-L	31122282121	31122341297	355 mm (Reinforced)	13	-	02251	Bushing-R	31126756064	-	-
7	BMW46-R	00125	Control arm complete-R	31122282122	31122341828	355 mm (Reinforced)	14	-	06759	Track control arm	33303411651	33321092237	-



7 06989
Standart Susp.



8 06990



7 06989
Standart Susp.



9 07038
Adaptive Susp.



8 06990



9 07038
Adaptive Susp.



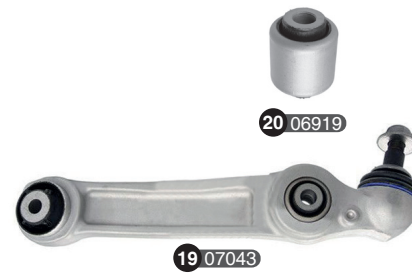



10 06997



11 06998



22 07753



23 07762



12 07002



13 07003



14 07005



3 07007



3 07007



Ref	Old code	CODE	Description	OE - Number	OE - Number	FEATURES	Ref	Old code	CODE	Description	OE - Number	OE - Number	FEATURES
1	-	06985	STABILIZER LINK	31306861483	-	-	15	-	07039	TRACK CONTROL ARM-LH (LOWER)	31106861151	-	-
2	-	07696	STABILIZER LINK	31306861485	-	-	16	-	07040	TRACK CONTROL ARM-RH (LOWER)	31106861152	-	-
3	-	07007	STABILIZER LINK (REAR)	33506861482	33506869096 PART OF	-	17	-	07041	BUSHING	31106861151 PART OF	31106861152 PART OF	-
4	-	06986	TIE ROD END-LH	32106868536	32106868685	-	18	-	07042	TRACK CONTROL ARM-LH (LOWER)	31106861169	-	-
5	-	06987	TIE ROD END-RH	32106868538	32106868687	-	19	-	07043	TRACK CONTROL ARM-RH (LOWER)	31106861170	-	-
6	-	06988	AXIAL JOINT	32106868688 PART OF	32106868689 PART OF	-	20	-	06919	BUSHING	31106861169 PART OF	31106861170 PART OF	-
7	-	06989	CONTROL ARM (UPPER) (COMPLETE)	31106861185	-	-	21	-	06996	BUSHING	31106861169 PART OF 1	31106861170 PART OF 1	-
8	-	06990	BUSHING	31106861185 PART OF	31106864374 PART OF	-	22	-	07753	TRACK ROD-LH	33322781469	33326861119	-
9	-	07038	CONTROL ARM (UPPER) (COMPLETE)	31106868530	-	-	23	-	07762	TRACK ROD-RH	33322781470	33326861120	-
10	-	06997	TRACK ROD-LH (REAR)	33326867537	-	-	24	-	07754	TRACK CONTROL ARM-LH	31106861157	-	-
11	-	06998	TRACK ROD-RH (REAR)	33326867538	-	-	25	-	07755	TRACK CONTROL ARM-RH	31106861158	-	-
12	-	07002	TRACK ROD-LH (REAR)	33326861125	-	-	26	-	07756	TRACK CONTROL ARM-LH	31106861173	-	-
13	-	07003	TRACK ROD-RH (REAR)	33326861126	-	-	27	-	07757	TRACK CONTROL ARM-RH	31106861174	-	-
14	-	07005	TRACK ROD (REAR)	33326861114	-	-	28	-	07758	BALL JOINT (LOWER)	31106852536	-	-



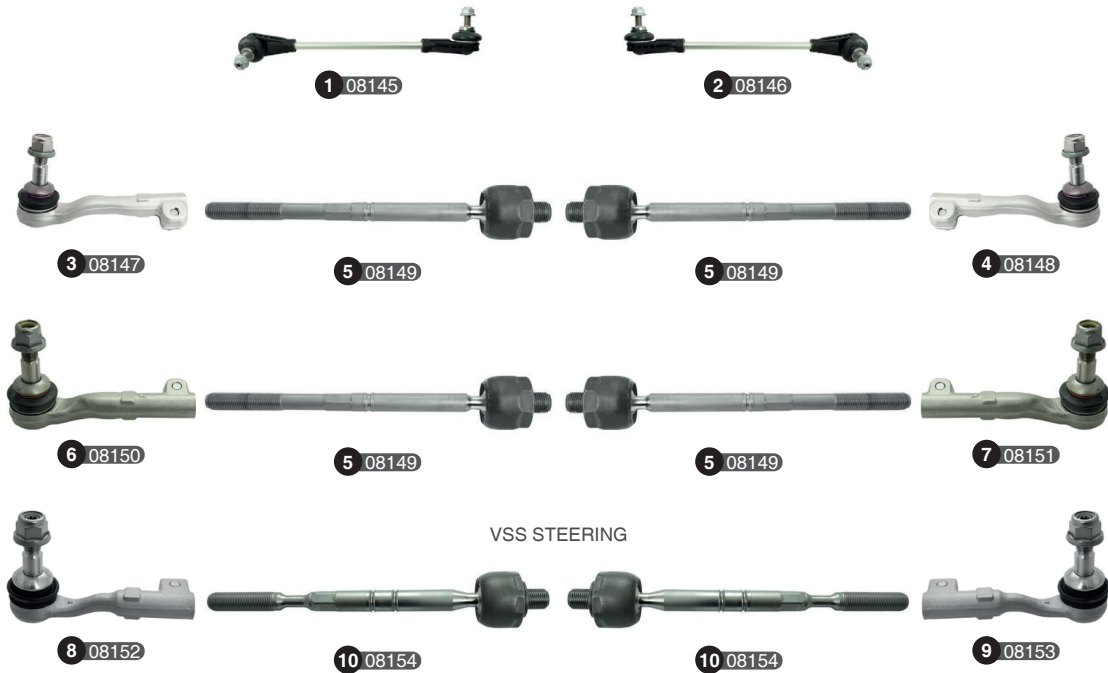

EXC. VSS + M SUSP.



XDRIVE EXC. VSS + M SUSP.





19 08163



20 08164



21 08165



21 08165



22 08166



22 08166



23 08167



23 08167



24 08168



25 08169



Ref	Old code	CODE	Description	OE - Number	OE - Number	FEATURES	Ref	Old code	CODE	Description	OE - Number	OE - Number	FEATURES
1	-	08145	STABILIZER LINK LH	31306893359	-	-	14	-	08158	TRACK CONTROL ARM LH (LOWER)	31106878071	31106878593	-
2	-	08146	STABILIZER LINK RH	31306893360	-	-	15	-	08159	TRACK CONTROL ARM RH (LOWER)	31106878072	31106878594	-
3	-	08147	TIE ROD END LH	32106871889	-	-	16	-	08160	BUSHING	31106878071 PART OF	31106878596 PART OF	-
4	-	08148	TIE ROD END RH	32106871893	-	-	17	-	08161	TRACK CONTROL ARM LH (LOWER)	31106894663	-	-
5	-	08149	AXIAL JOINT	32106871892 PART OF	32106880695 PART OF	-	18	-	08162	TRACK CONTROL ARM RH (LOWER)	31106894664	-	-
6	-	08150	TIE ROD END LH	32106880696	-	-	19	-	08163	TRACK ROD LH	33326878631	-	-
7	-	08151	TIE ROD END RH	32106880698	-	-	20	-	08164	TRACK ROD RH	33326878632	-	-
8	-	08152	TIE ROD END LH	32106887400	-	-	21	-	08165	TRACK ROD	33326881199	-	-
9	-	08153	TIE ROD END RH	32106887402	-	-	22	-	08166	TRACK ROD	31106879659	-	-
10	-	08154	AXIAL JOINT	32101543907 PART OF	32101543908 PART OF	-	23	-	08167	TRACK ROD	33306878639	-	-
11	-	08155	TRACK CONTROL ARM LH (LOWER)	31106894661	-	-	24	-	08168	STABILIZER LINK LH	33506785607 PART OF	-	-
12	-	08156	TRACK CONTROL ARM RH (LOWER)	31106894662	-	-	25	-	08169	STABILIZER LINK RH	33506785608 PART OF	-	-
13	-	08157	BUSHING	31106894661 PART OF	31106894662 PART OF	-							



DYNAMIC DRIVE



EXC. DYNAMIC DRIVE

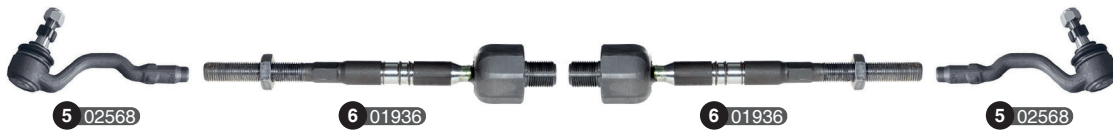

UPPER



LOWER





Ref	Old code	CODE	Description	OE - Number	OE - Number	FEATURES	Ref	Old code	CODE	Description	OE - Number	OE - Number	FEATURES
1	-	01934	Stabilizer link-L	37116771929	37116857627	"M12x1,5-247 mm (Front DYNAMIC DRIVE)"	13	-	06717	Track control arm-L	31126771893	-	Lower
							14	-	06718	Track control arm-R	31126771894	-	Lower
2	-	01935	Stabilizer link-R	37116771930	37116857628	"M12x1,5-247 mm (Front DYNAMIC DRIVE)"	15	-	06719	Bushing	31106771897	31126855509	Lower
							16	-	06720	Bushing	31106771194	-	Lower
3	-	01937	Stabilizer link-L	31356773023	31356857623	"M12x1,5-248,5 mm (Front EXC. DYNAMIC DRIVE)"	17	-	05180	Track control arm-L	33324046917	33326779387	-
							18	-	05181	Track control arm-R	33324046918	33326779388	-
							19	-	06719	Bushing	33316784940	-	-
4	-	01938	Stabilizer link-R	31356773024	31356857624	"M12x1,5-248,5 mm (Front EXC. DYNAMIC DRIVE)"	20	-	06782	Bushing	33176770947	-	-
							21	-	05178	Track control arm-L	33326770969	-	-
							22	-	05179	Track control arm-R	33326770970	-	-
5	-	02568	Tie rod end	32106780984	32106793497	-	23	-	06721	Bushing	33306779517	-	-
6	-	01936	Axial joint	32106780985	32106793496	M14x1,5- M18x1,5-219.5 mm	24	-	06723	Bushing	33176770948	-	-
7	-	06711	Control arm complete-L	31126776417	-	Upper	25	-	06724	Track rod	3332677476	-	-
8	-	06712	Control arm complete-R	31126776418	-	Upper	26	-	06726	Bushing	33326770952 PART OF	33326773632 PART OF	-
9	-	06713	Bushing	31126771199	31126772995 Part of	Upper	27	-	06725	Bushing	33326770985	-	-
10	-	06714	Track control arm-L	31126773949	-	Lower	28	-	06727	Bushing	33326770951 PART OF 1	33326770952 PART OF 1	-
11	-	06715	Track control arm-R	31126773950	-	Lower	29	-	01939	Stabilizer link	33556771937	33556857626	M12x1,5-160,2 mm (Rear)
12	-	06716	Bushing	31106778015	-	Lower							





1 08262



2 08263



3 08264



5 08266

STD. STEERING



5 08266



4 08265



6 08152



8 08154

VSS. STEERING



8 08154



7 08153

UPPER



9 08267



11 08269



10 08268

LOWER



12 08270



14 08272



13 08271



15 08273



17 06996



16 08274



18 06719



18 06719





Ref	Old code	CODE	Description	OE – Number	OE – Number	FEATURES	Ref	Old code	CODE	Description	OE – Number	OE – Number	FEATURES
1	-	08262	STABILIZER LINK LH	31356881807	-	-	15	-	08273	TRACK CONTROL ARM LH (LOWER)	31106878081	-	-
2	-	08263	STABILIZER LINK RH	31356881808	-	-	16	-	08274	TRACK CONTROL ARM RH (LOWER)	31106878082	-	-
3	-	08264	TIE ROD END LH	32106887405	-	-	17	-	06996	BUSHING	31106861169 PART OF 1	31106861177 PART OF 1	-
4	-	08265	TIE ROD END RH	32106887406	-	-	18	-	06719	BUSHING	31126855509	-	-
5	-	08266	AXIAL JOINT	32106884810 PART OF	32106884809 PART OF	-	19	-	08275	TRACK ROD LH	33306878017	-	-
6	-	08152	TIE ROD END LH	32106887400	-	-	20	-	08276	TRACK ROD RH	33306878018	-	-
7	-	08153	TIE ROD END RH	32106887402	-	-	21	-	06999	BUSHING	33316860421	-	-
8	-	08154	AXIAL JOINT	32101543907 PART OF	32101543908 PART OF	-	22	-	07004	BUSHING	33316860422	33316892574	-
9	-	08267	CONTROL ARM LH (LOWER) (COMPLETE)	31106883115	-	-	23	-	08277	TRACK ROD LH	33306878021	-	-
10	-	08268	CONTROL ARM RH (LOWER) (COMPLETE)	31106883116	-	-	24	-	08278	TRACK ROD RH	33306878022	-	-
11	-	08269	BUSHING	31106881320	31106883115 PART OF	-	25	-	08279	TRACK ROD	33306878037	-	-
12	-	08270	TRACK CONTROL ARM LH (LOWER)	31106893549	-	-	26	-	08280	TRACK ROD LH	33306878029	-	-
13	-	08271	TRACK CONTROL ARM RH (LOWER)	31106893550	-	-	27	-	08281	TRACK ROD RH	33306878030	-	-
14	-	08272	BUSHING	31106893549 PART OF	31106893550 PART OF	-	28	-	07006	BUSHING	33326861133	33326881781	-
							29	-	07007	STABILIZER LINK	33506861482	33506869096	-





Ref	Old code	CODE	Description	OE - Number	OE - Number	FEATURES	Ref	Old code	CODE	Description	OE - Number	OE - Number	FEATURES	
1	-	07133	STABILIZER LINK	31306858500	-	-	4	-	06910	CONTROL ARM (UPPER) (COMPLETE)	31126775967	-	-	
2	-	08354	TIE ROD END	32106858673	-	-		5	-	06913	BUSHING	31126775967 PART OF	31126779908 PART OF	-
3	-	08353	AXIAL JOINT	32106858672	-	-								